

Miniature Power PCB RYII & RYII Reflow Solderable

- 1 pole 8A, 1 form C (CO) or 1 form A (NO) or 1 form B (NC) contact
- Low component height 12.3mm
- 5kV/8mm coil-contact
- Reinforced insulation (protection class II)
- Pinnings: 3.2mm and 5mm
- Reflow-solderable version
- Especially suitable for resistive and inductive loads on form A (NO) and form B (NC) contacts
- Plastic materials according to IEC 60335-1 (domestic appliances)

Typical applications
heating control, interface technology, domestic appliances, timers, temperature control

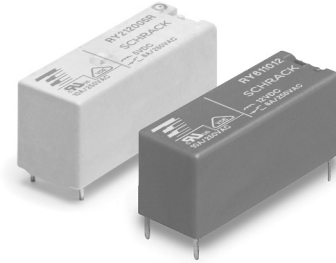

F0142-E



Approvals

VDE Cert. No. 40009639, UL E214025
Technical data of approved types on request

Contact Data

Contact arrangement	1 form C (CO) or 1 form A (NO) or 1 form B (NC)
Rated voltage	250VAC
Max. switching voltage	400VAC
Rated current	8A
Breaking capacity max.	2000VA
Contact material	AgNi0.15, AgSnO ₂
Frequency of operation, with/without load	6/1200min ⁻¹
Operate/release time max.	9/5ms
Bounce time max., form A/form B	6/10ms

Contact ratings

Type	Contact	Load	Cycles
IEC61810			
RY531	A (NO)	8A, 250VAC, 70°C	100x10 ³
RY211	A (NO)	8A, 250VAC, 75°C	100x10 ³
RY211	A (NO)	8A, 250VAC, 85°C	50x10 ³
RY211	B (NC)	8A, 250VAC, 70°C	50x10 ³
UL61810-1 (UL508)			
RY211	A/B (NO/NC)	10A, 250VAC, general purpose, 70°C	30x10 ³
RY211	A (NO)	1/2hp, 240VAC, 85°C	30x10 ³
RY211	B (NC)	B300, 70°C	6x10 ³
RY211	A (NO)	8A, 250VAC, 85°C	100x10 ³
RY211	A (NO)	8A, 24VDC, 85°C	30x10 ³
RY211	A (NO)	B300, 85°C	30x10 ³
RY211	A (NO)	C300, 105°C	30x10 ³
RY211	A (NO)	1/3 hp, 250VAC, 85°C	30x10 ³
RY211	A (NO)	1/4 hp, 120VAC, 70°C	30x10 ³
EN60730-1			
RY211	A/B (NO/NC)	6(4)A, 250VAC, 85°C	100x10 ³
RY211	A (NO)	8(4)A, 250VAC, 75°C	50x10 ³
RY211	A (NO)	8(4)A, 250VAC, 85°C	30x10 ³
RY211	A (NO)	2(2)A, 250VAC, -40 / +105°C	100x10 ³
RY211	C (CO)	2(2)A, 250VAC, -40 / +105°C	30x10 ³
Mechanical endurance, DC coil	30x10 ⁶ operations		

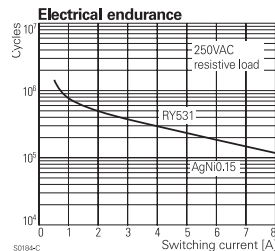
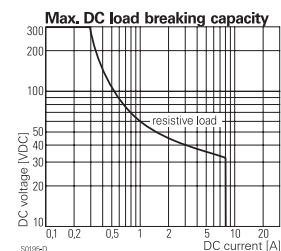

Coil Data

Coil voltage range	5 to 60VDC
Operative range, IEC 61810	2

Coil versions, DC coil

Coil code	Rated voltage VDC	Operate voltage VDC	Release voltage VDC	Coil resistance Ω±10%	Rated coil power mW
005	5	3.5	0.5	112	223
006	6	4.2	0.6	162	222
009	9	6.3	0.9	320	253
012	12	8.4	1.2	627	230
024	24	16.8	2.4	2350	245
048	48	33.6	4.8	9391	245
060	60	42.0	6.0	14000	257

All figures are given for coil without pre-energization, at ambient temperature +23°C
Other coil voltages on request

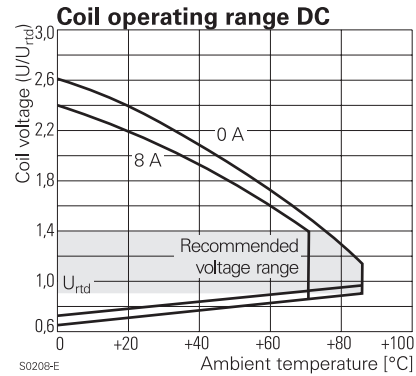

Insulation Data

Initial dielectric strength	
between open contacts	1000V _{rms}
between contact and coil	5000V _{rms}
Clearance/creepage	
between contact and coil	≥8/8mm
Material group of insulation parts	IIla
Tracking index of relay base	PTI250
reflow-solderable version	PTI175

Miniature Power PCB RYII & RYII Reflow Solderable (Continued)

Other Data

Material compliance: EU RoHS/ELV, China RoHS, REACH, Halogen content refer to the Product Compliance Support Center at www.te.com/customersupport/rohssupportcenter

Ambient temperature	-40 to +70°C +85°C at 6A
Category of environmental protection IEC 61810	RTII - flux proof RTIII - wash tight ¹⁾
Vibration resistance (functional), form A (NO)/form B (NC)	20/5g
Shock resistance (functional) form A (NO)/form B (NC)	20/5g
Shock resistance (destructive)	100g
Terminal type	PCB-THT, PCB-THR
Weight	8g
Resistance to soldering heat THT IEC 60068-2-20	RTII : 270°C/10s RTIII : 260°C/5s
Resistance to soldering heat THR IEC 60068-2-58	250°C, no infrared heating allowed
Packaging/unit standard version	tube/20 pcs., box/500 pcs.
reflow version	reel/280 pcs. box/1120 pcs. (4 reels)

¹⁾ not available as reflow-solderable version

Accessories

For details see datasheet [Accessories Miniature PCB Relay RY](#)

Dimensions

Pinning 3.2mm

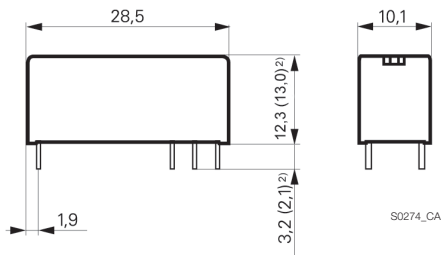

Pinning 5mm

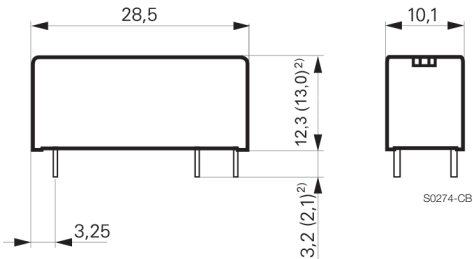

2) Values in brackets are valid for reflow-solderable version

PCB layout / terminal assignment

Bottom view on solder pins

1 form C (CO) contact, 3.2mm

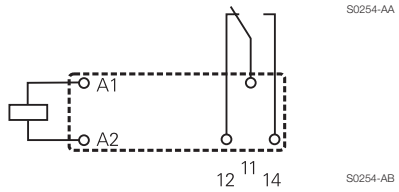
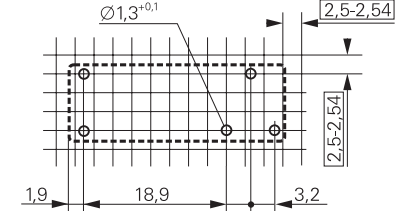

1 form A (NO), 1 form B (NC) contact 5mm

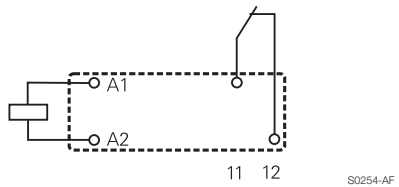
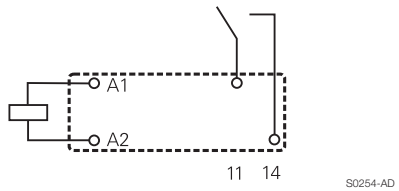
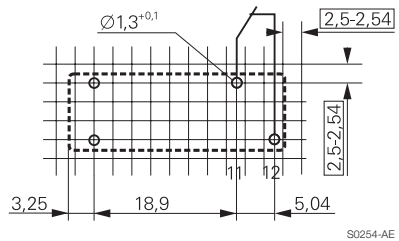
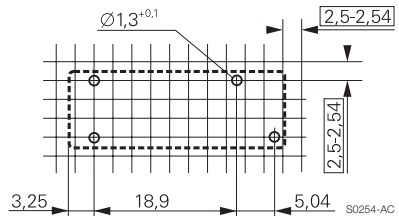

Miniature Power PCB RYII & RYII Reflow Solderable (Continued)

Soldering profile for reflow-solderable version

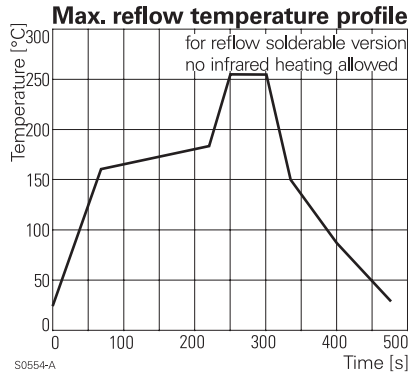

Tape dimensions

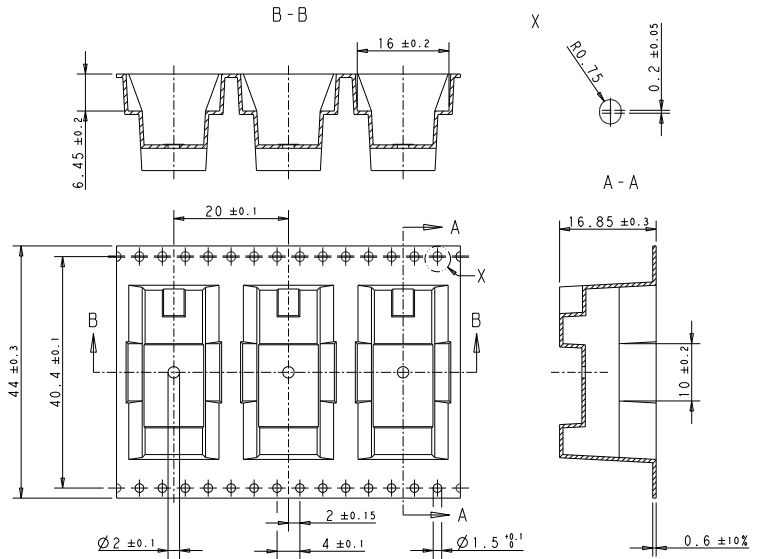

Reel dimensions

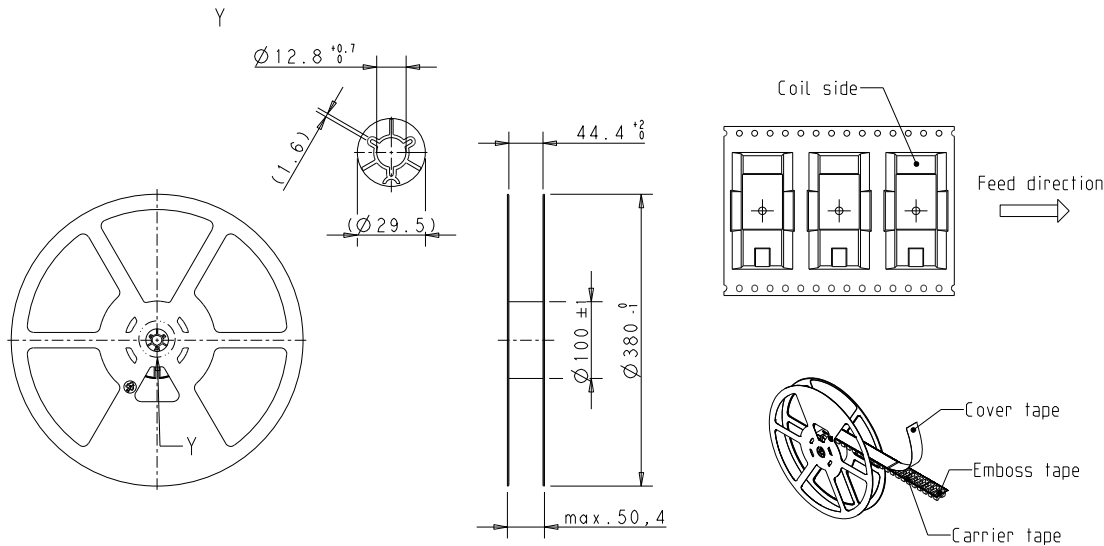

Product code structure

Typical product code **RY 6 1 1 012**

Type

RY Miniature Power PCB RYII & RYII reflow solderable

Version

- 2** pinning 3.2mm, flux proof
- 5** pinning 5mm, flux proof
- 6** pinning 3.2mm, wash tight ²⁾
- A** pinning 5mm, wash tight ²⁾

Contact arrangement

- 1** 1 form C (1 CO), pinning 3.2mm
- 3** 1 form A (1 NO), pinning 5mm
- 5** 1 form B (1 NC), pinning 5mm

Contact material

- 1** AgNi 0.15
- 3** AgSnO₂
- 2** AgNi 0.15 gold plated

Coil

Coil code: please refer to coil versions table

Version

- Blank** Standard version
- R** reflow-solderable

²⁾ not available as reflow-solderable version

Miniature Power PCB RYII & RYII Reflow Solderable (Continued)

Product code	Version	Contacts	Contact material	Coil	Part Number			
RY211005	Pinning 3.2 mm	1 form C,	AgNi 0.15	5VDC	4-1393224-2			
RY211006				6VDC	4-1393224-3			
RY211012	flux proof	1 CO contact		12VDC	4-1393224-6			
RY211024				24VDC	4-1393224-9			
RY211048				48VDC	5-1393224-1			
RY212005				5VDC	5-1393224-2			
RY212006			AgNi 0.15 gold plated	6VDC	5-1393224-3			
RY212012				12VDC	5-1393224-5			
RY212024				24VDC	5-1393224-8			
RY212048				48VDC	5-1393224-9			
RY213005			AgSnO ₂	5VDC	6-1393224-0			
RY213006				6VDC	9-1393224-0			
RY213012				12VDC	6-1393224-1			
RY213024				24VDC	6-1393224-2			
RY213048				48VDC	6-1393224-3			
RY531005				Pinning 5 mm	1 form A,	AgNi 0.15	5VDC	7-1393224-6
RY531006							flux proof	1 NO contact
RY531012								
RY531024	24VDC	8-1393224-2						
RY531048	48VDC	8-1393224-3						
RY532012			AgNi 0.15 gold plated				12VDC	8-1393224-4
RY532024				24VDC	8-1393224-5			
RY533006			AgSnO ₂	6VDC	8-1393224-6			
RY533012				12VDC	8-1393224-8			
RY533024				24VDC	8-1393224-9			
RY533048				48VDC	9-1393224-0			
RY611005	Pinning 3.2 mm	1 form C,	AgNi 0.15	5VDC	1-1393225-7			
RY611006				wash tight	1 CO contact	6VDC	1-1393225-8	
RY611012						12VDC	1-1393225-9	
RY611024				24VDC	2-1393225-1			
RY611048				48VDC	2-1393225-2			
RY612005						AgNi 0.15 gold plated	5VDC	2-1393225-3
RY612006	6VDC	2-1393225-4						
RY612012				12VDC	2-1393225-6			
RY612024				24VDC	2-1393225-9			
RY612048				48VDC	3-1393225-0			
RY613005						AgSnO ₂	5VDC	5-1419136-2
RY613012	12VDC	3-1393225-1						
RY613024				24VDC	3-1393225-3			
RY613048				48VDC	3-1393225-4			
RY631024				24VDC	4-1415400-1			
RYA31005				Pinning 5 mm	1 form A,	AgNi 0.15	5VDC	1393224-7
RYA31006	wash tight	1 NO contact	6VDC				1393224-8	
RYA31012						12VDC	1393224-9	
RYA31024	24VDC	1-1393224-2						
RYA31048	48VDC	1-1393224-3						
RYA32005						AgNi 0.15 gold plated	5VDC	1-1393224-4
RYA32006			6VDC	8-1393224-8				
RYA32012				12VDC	1-1393224-6			
RYA32024				24VDC	1-1393224-8			
RYA33005						AgSnO ₂	5VDC	1-1393224-9
RYA33024							24VDC	2-1393224-1

Product code	Version	Contacts	Contact material	Coil	Part number
RY211005R	pinning 3.2mm flux proof	1 form C,	AgNi 0.15	5VDC	1-1956170-2
RY211012R		1 CO contact		12VDC	1-1956170-6
RY211024R	reflow solderable			24VDC	1956164-1
RY531005R				1 form A,	5VDC
RY531012R	flux proof	1 NO contact		12VDC	1-1956171-4
RY531024R				reflow solderable	24VDC