

■ **Features**

- Universal AC input / Full range
- 3.3"x2" compact PCB size
- Models with L-Bracket and cover available (PSC-35x-C, x=A,B)
- Protections: Short circuit / Overload / Over voltage
- Battery low protection / Battery reverse polarity protection by fuse
- Alarm signal for AC OK and Battery low
- Cooling by free air convection
- 100% full load burn-in test
- 2 years warranty

■ **Applications**

- Security system
- Emergency lighting system
- Alarm system
- UPS system
- Central monitoring system
- Access systems

■ **Description**

PSC-35 series is a 35W AC/DC security power supply, allowing the universal input range between 90VAC and 264VAC and incorporating the built-in PFC function. In addition to the primary output, there is a charger output, with a smaller rated current, providing the backup application the security access systems normally need.

PSC-35 delivers an efficiency up to 86%; it can operate with air convection under -30°C through 70°C. This series is designed with thorough alarm features, including AC OK and battery low signaling; moreover, the relay contact is provided to facilitate users' system designs. PSC-35 is available in the PCB type (3.3" x 2") or the enclosed type with L-Bracket and cover.

■ **Model Encoding**

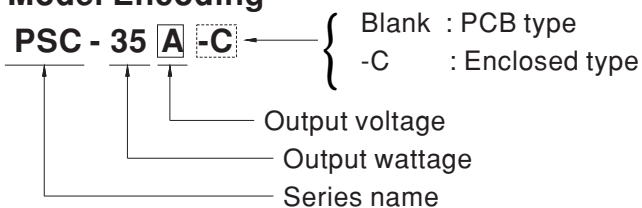



PSC-35A =Blank, -C ; Blank=PCB only, -C=Enclosed type

SPECIFICATION

MODEL		PSC-35A <input type="checkbox"/>		PSC-35B <input type="checkbox"/>	
OUTPUT	OUTPUT NUMBER	CH1	CH2	CH1	CH2
	DC VOLTAGE	13.8V	13.8V	27.6V	27.6V
	RATED CURRENT	1.7A	0.9A	0.85A	0.45A
	CURRENT RANGE	0 ~ 2.6A	-----	0 ~ 1.3A	-----
	RATED POWER	35.88W		35.88W	
	RIPPLE & NOISE (max.) Note.2	120mVp-p	-----	240mVp-p	-----
	VOLTAGE ADJ. RANGE	CH1: 12 ~ 15V		CH1: 24 ~ 29V	
	VOLTAGE TOLERANCE Note.3	± 1.0%	-----	± 1.0%	-----
	LINE REGULATION	± 0.5%	-----	± 0.5%	-----
	LOAD REGULATION	± 0.5%	-----	± 0.5%	-----
	SETUP, RISE TIME Note.4	800ms, 50ms/230VAC 1600ms, 50ms/115VAC at full load			
HOLD UP TIME (Typ.)	50ms/230VAC	10ms/115VAC at full load			
INPUT	VOLTAGE RANGE	90 ~ 264VAC	127 ~ 370VDC		
	FREQUENCY RANGE	47 ~ 63Hz			
	EFFICIENCY (Typ.)	84%		86%	
	AC CURRENT (Typ.)	0.75A/115VAC	0.5A/230VAC		
	INRUSH CURRENT (Typ.)	COLD START 20A/115VAC	40A/230VAC		
	LEAKAGE CURRENT	<1mA/ 240VAC			
PROTECTION	OVERLOAD	105 ~ 150% rated output power Protection type : Hiccup mode, recovers automatically after fault condition is removed			
	OVER VOLTAGE	CH1:14.49 ~ 19.5V		CH1:28.98 ~ 39.5V Protection type : Shut down O/P Voltage, repower on to recover	
	BATTERY CUT OFF	10 ± 0.5V		20 ± 1V	
FUNCTION	AC OK	TTL open collector output, ON : AC OK ; OFF : AC Fail ; Ice : max. 30mA@ 50VDC			
	BATTERY LOW	TTL open collector output, ON : Battery Low ; OFF : Battery OK ; Ice : max. 30mA@ 50VDC Battery low voltage : < 11V		Battery low voltage : < 22V	
ENVIRONMENT	WORKING TEMP.	-30 ~ +70°C (Refer to "Derating Curve")			
	WORKING HUMIDITY	20 ~ 90% RH non-condensing			
	STORAGE TEMP., HUMIDITY	-20 ~ +85°C, 10 ~ 95% RH			
	TEMP. COEFFICIENT	± 0.03%/°C (0~50°C) on CH1 output			
	VIBRATION	10 ~ 500Hz, 2G 10min./1cycle, 60min. each along X, Y, Z axes			
SAFETY & EMC (Note 4)	SAFETY STANDARDS	UL62368-1, TUV EN62368-1, EAC TP TC 004 approved			
	WITHSTAND VOLTAGE	I/P-O/P:3KVAC I/P-FG:2KVAC O/P-FG:0.5KVAC			
	ISOLATION RESISTANCE	I/P-O/P, I/P-FG, O/P-FG:100M Ohms / 500VDC / 25°C / 70% RH			
	EMC EMISSION	Compliance to EN55032 (CISPR32) Class B, EN61000-3-2,-3, EAC TP TC 020			
	EMC IMMUNITY	Compliance to EN61000-4-2,3,4,5,6,8,11, EN55024, light industry level, criteria A, EAC TP TC 020			
OTHERS	MTBF	658.4 K hrs min. MIL-HDBK-217F (25°C)			
	DIMENSION	PCB:84.6*50.8*24mm (L*W*H) ; Enclosed type:86.4*59.6*30mm (L*W*H)			
	PACKING	PCB:0.092Kg;90pcs/9.28Kg/0.97CUFT ; Enclosed type: 0.145Kg;100pcs/15.5Kg/1.03CUFT			
NOTE	<p>1. All parameters NOT specially mentioned are measured at 230VAC input, rated load and 25°C of ambient temperature.</p> <p>2. Ripple & noise are measured at 20MHz of bandwidth by using a 12" twisted pair-wire terminated with a 0.1uf & 47uf parallel capacitor.</p> <p>3. Tolerance : includes set up tolerance, line regulation and load regulation.</p> <p>4. Length of set up time is measured at first cold start. Turning ON/OFF the power supply may lead to increase of the set up time.</p> <p>5. Heat sink HS1,HS2 can not be shorted.</p> <p>6. Heat sink HS1 must have safety isolation distance with system case.</p> <p>7. The power supply is considered a component which will be installed into a final equipment. The final equipment must be re-confirmed that it still meets EMC directives. For guidance on how to perform these EMC tests, please refer to "EMI testing of component power supplies." (as available on http://www.meanwell.com)</p> <p>8. The ambient temperature derating of 3.5°C/1000m with fanless models and of 5°C/1000m with fan models for operating altitude higher than 2000m(6500ft).</p> <p>※ Product Liability Disclaimer : For detailed information, please refer to https://www.meanwell.com/serviceDisclaimer.aspx</p>				

■ Block Diagram

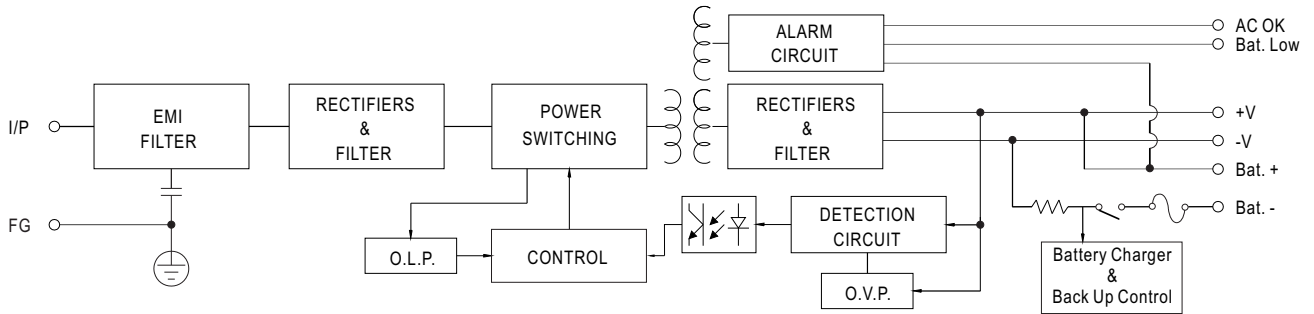

■ Output Derating

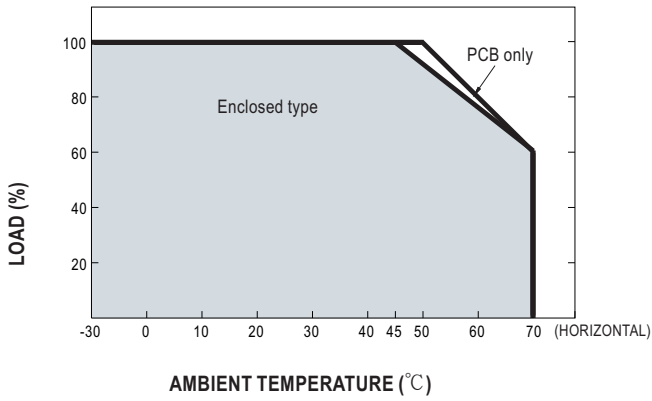

■ Output Derating VS Input Voltage

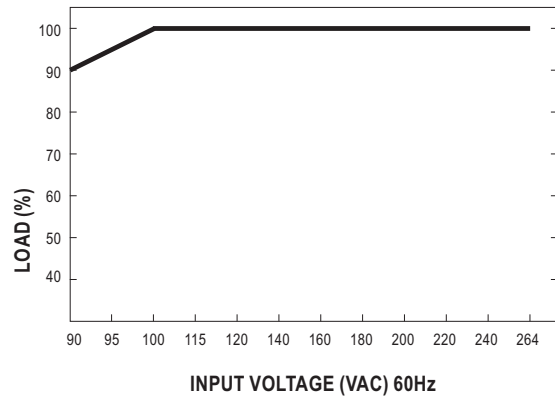

■ Suggested Application

1. Backup connection for AC interruption

(1) Please refer to the Fig1.1 for suggested connection.

The power supply charges the battery and provides energy to the load at the same time when the AC main is OK.
The battery starts to supply power to the load when the AC mains fails.

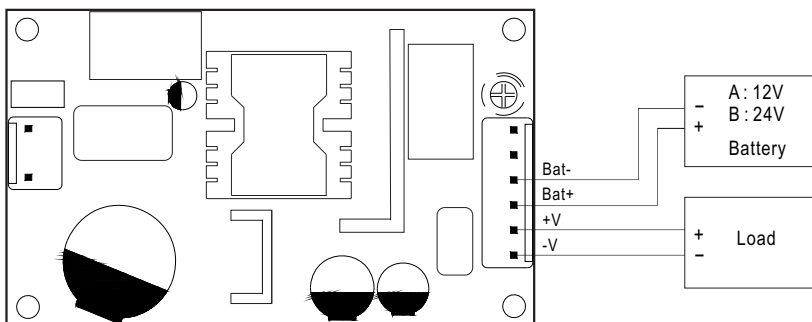

Fig 1.1 Suggested system connection

2. Alarm Signal for AC OK and Battery Low

- (1) Alarm Signal is sent out through "AC OK" & "Battery Low" pins.
- (2) An external voltage source is required for this function. The maximum applied voltage is 50V and the maximum sink current is 30mA.
- (3) Table 2.1 explains the alarm function built in the power supply

Function	Description	Output of alarm
AC OK	The signal is "Low" when the power supply turns on	Low (0.3V max. at 30mA)
	The signal turns to be "High" when the power supply turns OFF	High or open(External applied voltage 50V max.)
Battery Low	The signal is "Low" when the voltage of battery is under A:11V, B:22V	Low (0.3V max. at 30mA)
	The signal is "High" when the voltage of battery is above A:11V, B:22V	High or open(External applied voltage 50V max.)

Table 2.1 Explanation of Alarm Signal

AC OK (Battery low)

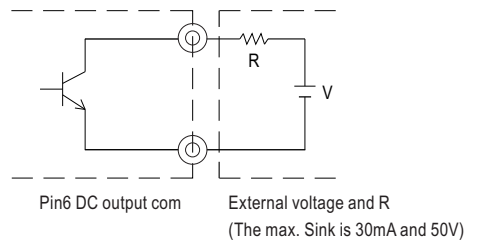
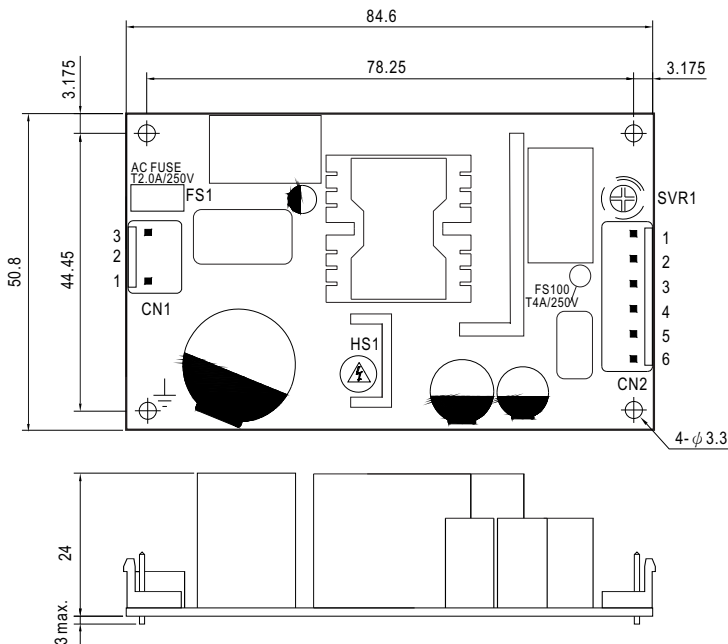

Fig 2.2 Internal circuit of AC OK (Battery Low)

■ Mechanical Specification

Unit:mm



- 1. HS1, HS2 can not be shorted.
- 2. HS1 must have safety isolation distance with system case.
- 3. ⚡ Gronding required
- 4. -V and Bat- can not be shorted

AC Input Connector (CN1) : JST B3P-VH or equivalent

Pin No.	Assignment	Mating Housing	Terminal
1	AC/N	JST VHR or equivalent	JST SVH-21T-P1.1 or equivalent
2	No Pin		
3	AC/L		

DC Output Connector (CN2) : JST B6P-VH or equivalent

Pin No.	Assignment	Pin No.	Assignment	Mating Housing	Terminal
1	Bat. Low	4	Battery +	JST VHR or equivalent	JST SVH-21T-P1.1 or equivalent
2	AC OK	5	+V		
3	Battery -	6	-V		

■ Installation Manual

Please refer to : <http://www.meanwell.com/manual.html>

