

Features

- For LED Outdoor & Industrial Application
- Wide Input Range for Worldwide use (up to 305Vac)
- Built-in PFC Function: up to PF 0.98
- IP67 Design for Outdoor Installation
- Suitable to Dry, Damp, Wet Location
- High Surge Protection: 6kV/6kV(IEC61000-4-5)
- 3 in 1 dimming: 1-10V/PWM/Resistance
- High Reliability & Long Life 50,000hrs
- Constant Current Design/ Low Ripple Current
- All-Round Protections: Short Circuit/ Over Voltage/ Over Temperature
- Safety: Meet IEC61347-2-13, UL8750 & EMI EN55015



FSP320-SZAE(XXX)MG
M Type: IP67 rated with 1-10V, PWM Dimming Function
R Type: IP65 rated and output current can be adjusted through internal potentiometer



SPECIFICATION

Model Name	FSP320-SZAE(105)MG [8]	FSP320-SZAE(140)MG	FSP320-SZAE(210)MG	FSP320-SZAE(280)MG	
Output	Rated Power	320.25W	320.6W	319.2W	319.2W
	Output Voltage	152-305V	114-229V	76-152V	57-114V
	Rated Current	1.05A	1.4A	2.1A	2.8A
	Output Current Accuracy	±5%	±5%	±5%	±5%
	Output Ripple Current (typ.) [2]	±5%	±5%	±5%	±5%
	Line Regulation	±1%	±1%	±1%	±1%
	Turn On Delay Time ; Rise time	≤1s max ; ≤300ms max			
Input	Input Voltage/ Frequency [3]	90~305Vac/ 47~63Hz (Please refer to Static Curve)			
	Power Factor (typ.)	PF ≥ 0.98/120Vac, PF ≥ 0.95/230Vac, PF ≥ 0.92/277Vac at full load			
	Efficiency (max.)	94%	94%	94%	94%
	Total Harmonic Distortion [4]	THD <20% (Output Loading ≥50% at 120-277Vac)			
	AC Current (typ.)	≤3.5A /120Vac ; ≤1.56A /230Vac ; ≤1.45A /277Vac			
	Inrush Current (typ.)	≤80A at 230Vac, 25°C cold start			
Leakage Current	≤2.5mA/277Vac				
Environment	Operating Temperature	-40°C ~ +70°C (Please Refer to "Derating Curve")			
	Operating Humidity	10~95% RH non-condensing			
	Storage Temperature, Humidity	-40°C~+85°C, 5%~95%RH			
	Vibration	0.02g ² /Hz at 5 Hz sloping to 0.04g ² /Hz at 20 Hz, and maintaining 0.04g ² /Hz from 20 Hz to 500 Hz at a constant acceleration of 4.43G for 30 minutes per axis for all three axes			
Protection	Over Voltage Protection	<400V	<400V	<200V	<200V
	Short Circuit Protection	Recovery Type: Recovers automatically after fault condition is removed			
	Over Temperature Protection	Recovery Type: Recovers automatically after fault condition is removed			
Safety & EMC	Safety Standards	Design Refer to EN61347-1, EN61347-2-13, UL8750			
	EMC Standard	Compliant with EN55015/CISPR22 CLASS B, Compliant with EN61000-3-2 Class C (≥80% load), EN61000-3-3			
	Surge Protection	Differential Mode: 6KV; Common Mode: 6KV			
	Withstand Voltage (Hipot)	I/P-O/P 3600Vac, I/P-FG 1500Vac, O/P-FG 1500Vac			
Others	Isolation Resistance	I/P-O/P: 100M ohm @ 500Vdc/ 25°C			
	Life Time [5]	50,000 hours at Tcase of ≤ 80°C			
	MTBF	200,000 hours, MIL-HDBK-217F(25°C)			
	Dimension (LxWxH)	260 x 84 x 42.5 mm			
Net Weight / Packing	1650g; 10 pcs/ box				

- Notes:
1. All data NOT specially mentioned are measured at 230Vac/ 50Hz input, full load and 25°C of ambient temperature.
 2. The ripple current must be measured under the condition of AC coupling & 20MHz bandwidth. (Rated input and rated output)
 3. Derating may be needed under low input voltages. Please check the static characteristics for more details.
 4. Measured at rated output voltage.
 5. Measured at 230Vac/50Hz input, rated load.
 6. Length of set up time is measured at first cold start. Turning ON/OFF the may lead to increase of the set up time.driver.
 7. The power supply is considered as a component that will be operated in combination with final equipment. Since EMC performance will be affected by the complete installation, the final equipment manufacturers must re-qualify EMC Directive on the complete installation again.
 8. UL/CE safety pending



Derating Curve

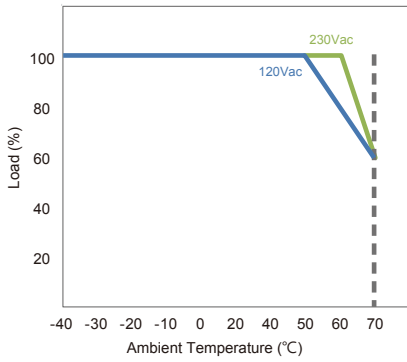

Static Curve

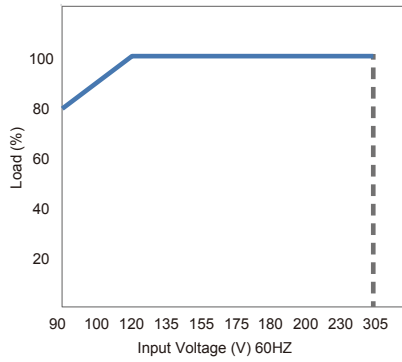

Life Time

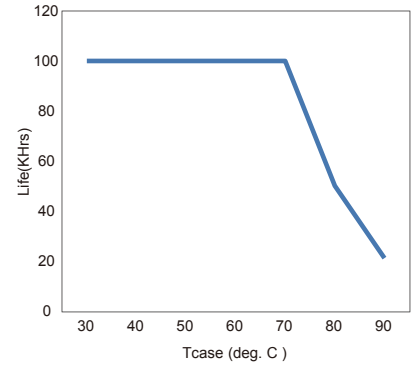

Efficiency

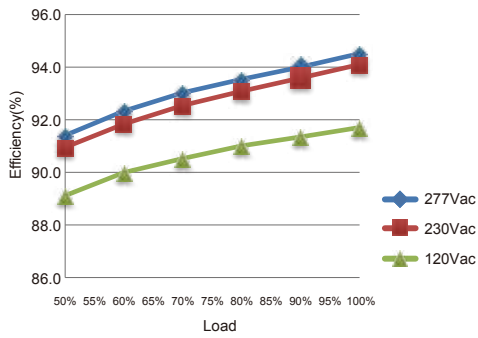

PFC vs Loading

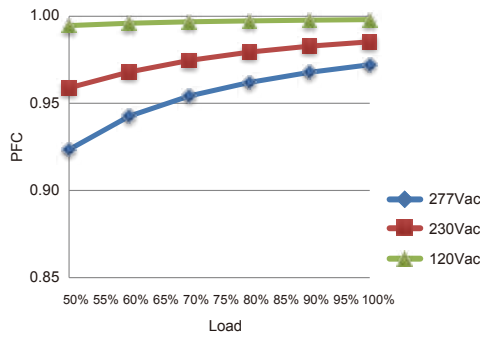

THD vs loading

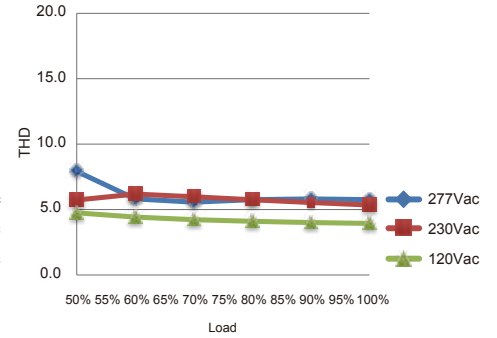

0-10V Dimming Curve

*Direct connecting to LEDs is suggested

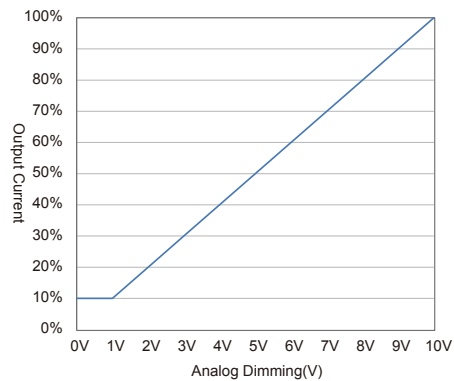
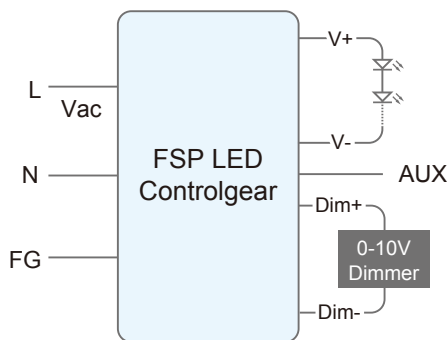

FSP TECHNOLOGY INC.

www.fsp-group.com / sales@fsp-group.com.tw
 NO.22, Jianguo E. Rd., Taoyuan City, Taiwan, R.O.C.
 TEL : +886-3-375-9888 / FAX : +886-3-375-6966

MG Type: FSP320-SZAE(XXX)MG

Unit: mm

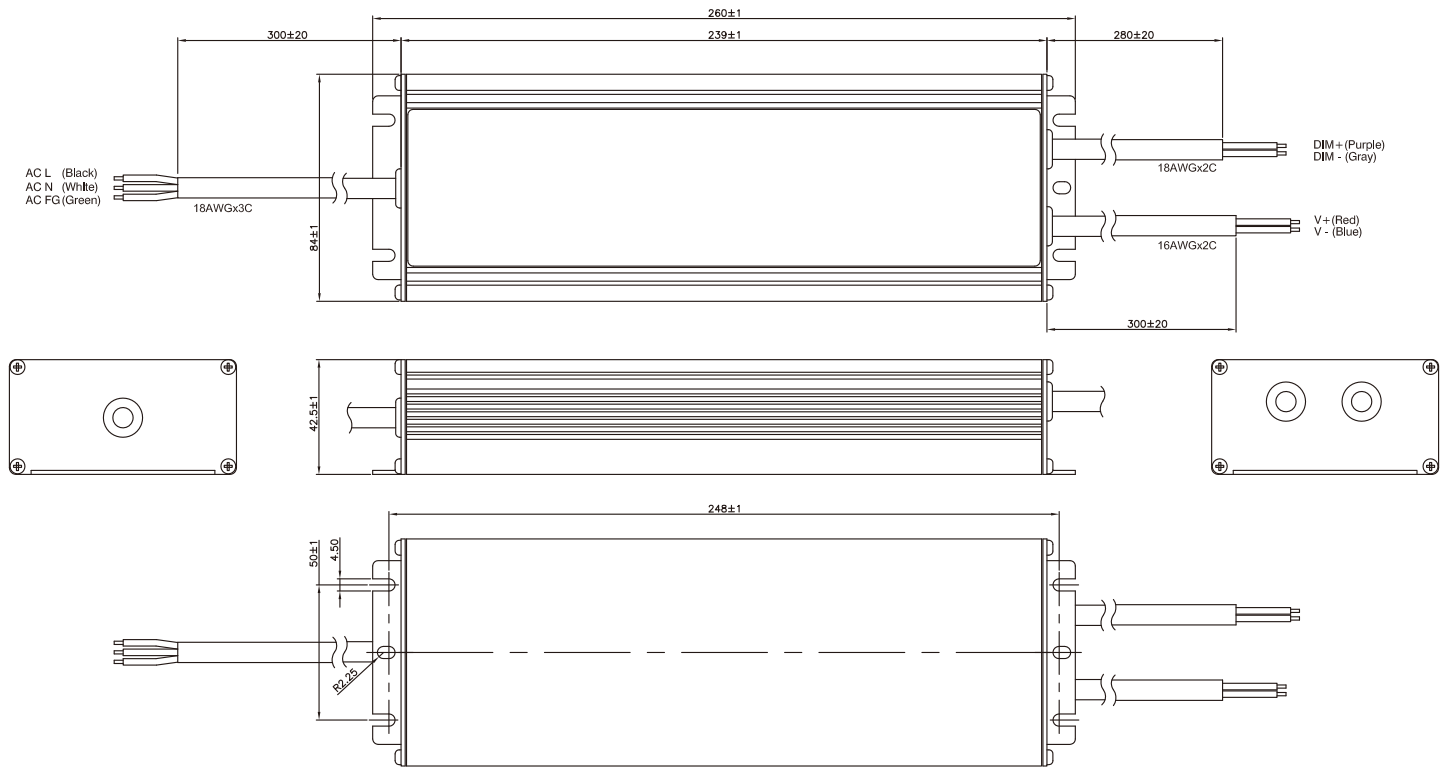

RG Type: FSP320-SZAE(XXX)RG

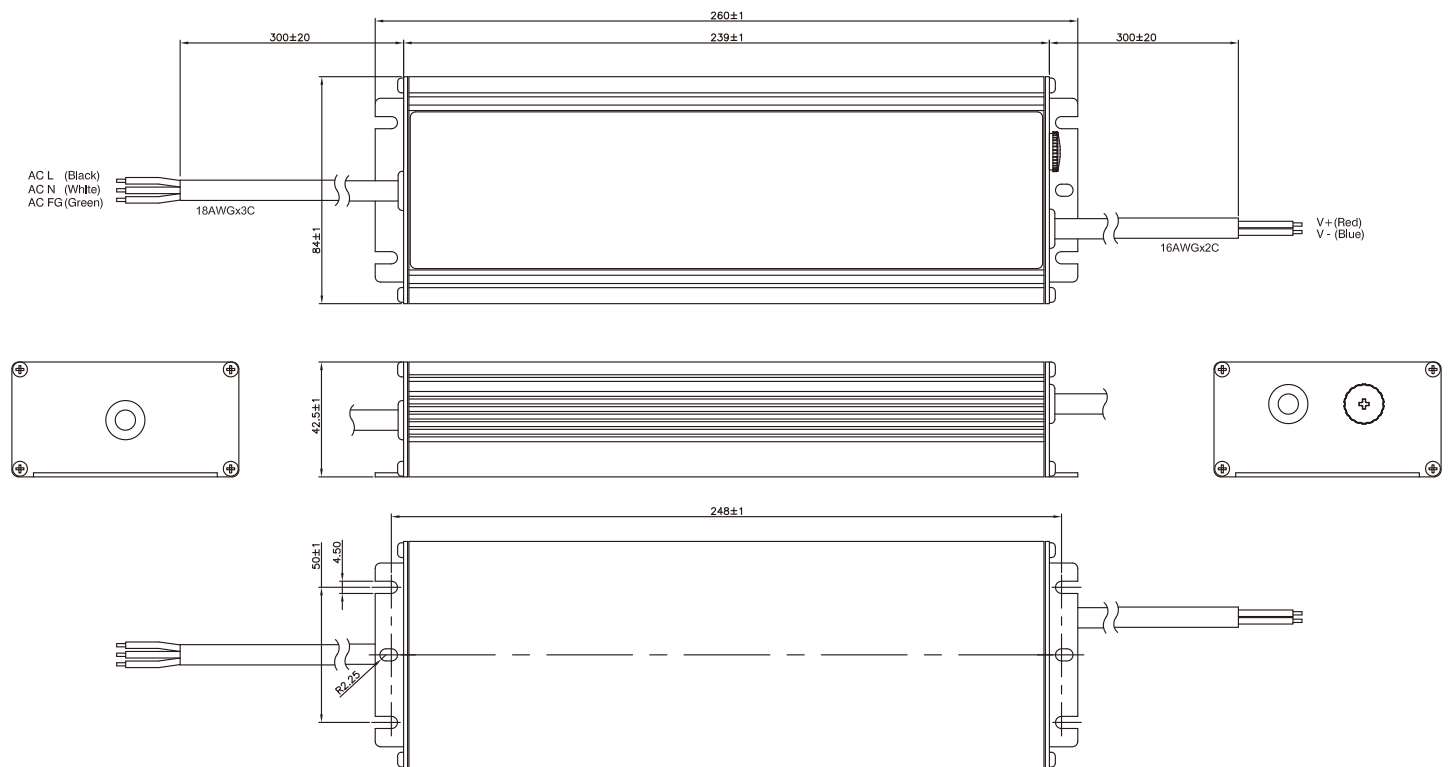

FSP TECHNOLOGY INC.

www.fsp-group.com / sales@fsp-group.com.tw
 NO.22, Jianguo E. Rd., Taoyuan City, Taiwan, R.O.C.
 TEL : +886-3-375-9888 / FAX : +886-3-375-6966