

MODEL:
NANO-ULT5

EPIC SBC with 14nm Intel® Core™ i7/i5/i3 or Celeron® On-board SoC, LVDS, HDMI, DP, Dual PCIe GbE, USB 3.2 Gen 2, M.2, PCIe Mini, SATA 6Gb/s, RS-232/422/485, Audio, TPM and RoHS

User Manual

Revision

Date	Version	Changes
February 24, 2020	1.02	Modified Table 3-10: LVDS Connector Pinouts
November 5, 2019	1.01	Modified Section 3.3.3: LAN Connectors
May 21, 2019	1.00	Initial release

Copyright

COPYRIGHT NOTICE

The information in this document is subject to change without prior notice in order to improve reliability, design and function and does not represent a commitment on the part of the manufacturer.

In no event will the manufacturer be liable for direct, indirect, special, incidental, or consequential damages arising out of the use or inability to use the product or documentation, even if advised of the possibility of such damages.

This document contains proprietary information protected by copyright. All rights are reserved. No part of this manual may be reproduced by any mechanical, electronic, or other means in any form without prior written permission of the manufacturer.

TRADEMARKS

All registered trademarks and product names mentioned herein are used for identification purposes only and may be trademarks and/or registered trademarks of their respective owners.

Manual Conventions



WARNING

Warnings appear where overlooked details may cause damage to the equipment or result in personal injury. Warnings should be taken seriously.



CAUTION

Cautionary messages should be heeded to help reduce the chance of losing data or damaging the product.



NOTE

These messages inform the reader of essential but non-critical information. These messages should be read carefully as any directions or instructions contained therein can help avoid making mistakes.

Table of Contents

1 INTRODUCTION.....	1
1.1 INTRODUCTION.....	2
1.2 MODEL VARIATIONS	3
1.3 FEATURES.....	3
1.4 CONNECTORS	4
1.5 DIMENSIONS.....	5
1.6 DATA FLOW	6
1.7 TECHNICAL SPECIFICATIONS	7
2 UNPACKING	10
2.1 ANTI-STATIC PRECAUTIONS	11
2.2 UNPACKING PRECAUTIONS.....	11
2.3 PACKING LIST.....	12
2.4 OPTIONAL ITEMS.....	13
3 CONNECTORS	14
3.1 PERIPHERAL INTERFACE CONNECTORS.....	15
3.1.1 NANO-ULT5 Layout	15
3.1.2 Peripheral Interface Connectors	16
3.1.3 External Interface Panel Connectors.....	17
3.2 INTERNAL PERIPHERAL CONNECTORS	18
3.2.1 Audio Connector	18
3.2.2 Battery Connector.....	19
3.2.3 Digital I/O Connector	21
3.2.4 Fan Connector	22
3.2.5 Front Panel Connector	23
3.2.6 Keyboard and Mouse Connector	24
3.2.7 LAN LED Connectors	25
3.2.8 LVDS LCD Connector	25
3.2.9 LVDS Backlight Inverter Connector	27
3.2.10 M.2 Slot, A-key.....	28

3.2.11 M.2 Slot, M-key	30
3.2.12 DDR4 SO-DIMM Sockets	32
3.2.13 PCIe Mini Card Slot, Full-size	32
3.2.14 Power Connector	34
3.2.15 Power Button Connector.....	35
3.2.16 Reset Button Connector	36
3.2.17 RS-232 Serial Port Connector	37
3.2.18 RS-422/485 Serial Port Connector	38
3.2.19 SATA 6Gb/s Drive Connectors.....	39
3.2.20 SATA Power Connectors	40
3.2.21 SMBus/I ² C Connector.....	41
3.2.22 SIM Card Slot.....	42
3.2.23 SPI Flash Connector.....	43
3.2.24 TPM Connector.....	44
3.2.25 USB 2.0 Connector	45
3.3 EXTERNAL PERIPHERAL INTERFACE CONNECTOR PANEL	46
3.3.1 DisplayPort Connector	47
3.3.2 HDMI Connector	48
3.3.3 LAN Connectors.....	49
3.3.4 RS-232 Serial Port Connector	50
3.3.5 USB 3.2 Gen 2 (10Gb/s) Connectors.....	51
4 INSTALLATION	52
4.1 ANTI-STATIC PRECAUTIONS.....	53
4.2 INSTALLATION CONSIDERATIONS.....	53
4.3 SO-DIMM INSTALLATION	55
4.4 M.2 MODULE INSTALLATION.....	56
4.5 PCIe MINI CARD INSTALLATION	57
4.6 SIM CARD INSTALLATION	58
4.7 SYSTEM CONFIGURATION.....	60
4.7.1 AT/ATX Mode Select Switch.....	60
4.7.2 Clear CMOS Button.....	61
4.7.3 Backlight Mode Select Jumper.....	62
4.7.4 Flash Descriptor Security Override Jumper.....	63
4.7.5 LCD Voltage Selection	64

NANO-ULT5 SBC

4.7.6 LVDS Panel Resolution Select Switch	65
4.8 CHASSIS INSTALLATION.....	67
4.8.1 Heat Spreader	67
4.8.2 Motherboard Installation Example.....	68
4.9 INTERNAL PERIPHERAL DEVICE CONNECTIONS.....	69
4.9.1 AT Power Connection	69
4.9.2 Audio Kit Installation.....	70
4.9.3 RS-232 Cable Connection.....	71
4.9.4 SATA Drive Connection	72
4.10 INTEL [®] AMT SETUP PROCEDURE.....	74
5 BIOS.....	75
5.1 INTRODUCTION.....	76
5.1.1 Starting Setup.....	76
5.1.2 Using Setup	76
5.1.3 Getting Help.....	77
5.1.4 Unable to Reboot after Configuration Changes	77
5.1.5 BIOS Menu Bar.....	77
5.2 MAIN.....	78
5.3 ADVANCED.....	79
5.3.1 CPU Configuration.....	80
5.3.2 PCH-FW Configuration.....	82
5.3.3 Trusted Computing.....	83
5.3.4 ACPI Settings	84
5.3.5 RTC Wake Settings.....	85
5.3.6 iWDD H/W Monitor.....	86
5.3.6.1 Smart Fan Mode Configuration	87
5.3.7 F81866 Super IO Configuration	89
5.3.7.1 Serial Port n Configuration.....	90
5.3.8 Serial Port Console Redirection	91
5.3.8.1 Legacy Console Redirection Settings.....	92
5.3.8.2 Console Redirection Settings.....	93
5.3.9 USB Configuration.....	95
5.3.10 CSM Configuration.....	96
5.3.11 NVMe Configuration.....	97

5.3.12 IEI Feature	98
5.4 CHIPSET	99
5.4.1 System Agent (SA) Configuration	99
5.4.1.1 Memory Configuration	100
5.4.1.2 Graphics Configuration.....	101
5.4.2 PCH-IO Configuration	103
5.4.2.1 PCI Express Configuration	105
5.4.2.1.1 M2_A1 / MINI_PCIE1 / M2_M2 Configuration.....	105
5.4.2.2 SATA And RST Configuration.....	107
5.5 SECURITY.....	109
5.6 BOOT.....	110
5.7 EXIT	112
6 SOFTWARE DRIVERS	114
6.1 AVAILABLE DRIVERS	115
6.2 DRIVER DOWNLOAD	115
A REGULATORY COMPLIANCE	118
B PRODUCT DISPOSAL	120
C BIOS MENU OPTIONS.....	122
D DIGITAL I/O INTERFACE.....	125
E WATCHDOG TIMER.....	128
F ERROR BEEP CODE	131
F.1 PEI BEEP CODES	132
F.2 DXE BEEP CODES	132
G HAZARDOUS MATERIALS DISCLOSURE.....	133
G.1 RoHS II DIRECTIVE (2015/863/EU)	134
G.2 CHINA RoHS.....	135

List of Figures

Figure 1-1: NANO-ULT5	2
Figure 1-2: Connectors	4
Figure 1-3: Dimensions (mm)	5
Figure 1-4: Data Flow Diagram	6
Figure 3-1: Connector and Jumper Locations	15
Figure 3-2: Audio Connector Location	18
Figure 3-3: Battery Connector Location	20
Figure 3-4: Digital I/O Connector Location	21
Figure 3-5: Fan Connector Location	22
Figure 3-6: Front Panel Connector Location	23
Figure 3-7: Keyboard and Mouse Connector Location	24
Figure 3-8: LAN LED Connector Locations	25
Figure 3-9: LVDS Connector Location	26
Figure 3-10: Backlight Inverter Connector Location	27
Figure 3-11: M.2 A-key Slot Location	28
Figure 3-12: M.2 M-key Slot Location	30
Figure 3-13: DDR4 SO-DIMM Socket Locations	32
Figure 3-14: Full-size PCIe Mini Card Slot Location	33
Figure 3-15: +12V DC-IN Power Connector Location	34
Figure 3-16: Power Button Connector Location	35
Figure 3-17: Reset Button Connector Location	36
Figure 3-18: RS-232 Serial Port Connector Location	37
Figure 3-19: RS-422/485 Connector Location	38
Figure 3-20: SATA 6Gb/s Drive Connectors Locations	39
Figure 3-21: SATA Power Connector Locations	40
Figure 3-22: SMBus Connector Location	41
Figure 3-23: SIM Card Slot Location	42
Figure 3-24: SPI Flash Connector Location	43
Figure 3-25: TPM Connector Pinout Locations	44
Figure 3-26: USB Connector Location	45
Figure 3-27: External Peripheral Interface Connector	46

Figure 3-28: DisplayPort Connector Pinout Locations.....	47
Figure 3-29: HDMI Connector Pinout Locations.....	48
Figure 3-30: LAN Connector.....	49
Figure 3-31: Serial Port Pinouts.....	50
Figure 3-32: USB 3.2 Gen 2 Port Pinouts.....	51
Figure 4-1: SO-DIMM Installation.....	55
Figure 4-2: Inserting the M.2 Module into the Slot at an Angle.....	56
Figure 4-3: Securing the M.2 Module.....	56
Figure 4-4: Removing the Retention Screw.....	57
Figure 4-5: Inserting the Full-size PCIe Mini Card into the Slot at an Angle.....	57
Figure 4-6: Securing the Full-size PCIe Mini Card.....	58
Figure 4-7: Unlock SIM Card Slot Cover.....	58
Figure 4-8: SIM Card Installation.....	59
Figure 4-9: Lock SIM Card Slot Cover.....	59
Figure 4-10: AT/ATX Mode Select Switch Location.....	60
Figure 4-11: Clear CMOS Button Location.....	61
Figure 4-12: Backlight Mode Select Jumper Location.....	62
Figure 4-13: Flash Descriptor Security Override Jumper Location.....	63
Figure 4-14: LCD Voltage Selection Jumper Location.....	65
Figure 4-15: LVDS Panel Resolution Select Switch Location.....	66
Figure 4-16: Heat Sink Retention Screws.....	68
Figure 4-17: Motherboard Installation Example.....	68
Figure 4-18: Power Cable to Motherboard Connection.....	69
Figure 4-19: Connect Power Cable to Power Supply.....	70
Figure 4-20: Audio Kit Cable Connection.....	71
Figure 4-21: Single RS-232 Cable Installation.....	72
Figure 4-22: SATA Drive Cable Connection.....	73
Figure 6-1: IEI Resource Download Center.....	115

List of Tables

Table 1-1: NANO-ULT5 Model Variations	3
Table 1-2: Technical Specifications	9
Table 3-1: Peripheral Interface Connectors	17
Table 3-2: Rear Panel Connectors	17
Table 3-3: Audio Connector Pinouts	18
Table 3-4: Battery Connector Pinouts	20
Table 3-5: Digital I/O Connector Pinouts	21
Table 3-6: Fan Connector Pinouts	22
Table 3-7: Front Panel Connector Pinouts	23
Table 3-8: Keyboard and Mouse Connector Pinouts	24
Table 3-9: LAN LED Connector Pinouts	25
Table 3-10: LVDS Connector Pinouts	27
Table 3-11: Backlight Inverter Connector Pinouts	27
Table 3-12: M.2 A-Key Slot Pinouts	29
Table 3-13: M.2 M-Key Slot Pinouts	31
Table 3-14: Full-size PCIe Mini Card Slot Pinouts	34
Table 3-15: +12V DC-IN Power Connector Pinouts	34
Table 3-16: Power Button Connector Pinouts	35
Table 3-17: Reset Button Connector Pinouts	36
Table 3-18: RS-232 Serial Port Connector Pinouts	37
Table 3-19: RS-422/485 Connector Pinouts	38
Table 3-20: SATA Power Connector Pinouts	40
Table 3-21: SMBus Connector Pinouts	41
Table 3-22: SPI Flash Connector Pinouts	43
Table 3-23: TPM Connector Pinouts	44
Table 3-24: USB Connector Pinouts	45
Table 3-25: DisplayPort Connector Pinouts	47
Table 3-26: HDMI Connector Pinouts	48
Table 3-27: LAN Pinouts	49
Table 3-28: LAN Connector LEDs	49
Table 3-29: Serial Port Pinouts	50

Table 3-30: USB 3.2 Gen 2 Port Pinouts.....	51
Table 4-1: AT/ATX Mode Select Switch Settings.....	60
Table 4-2: Backlight Mode Select Jumper Settings	62
Table 4-3: Flash Descriptor Security Override Jumper Settings	63
Table 4-4: LCD Voltage Selection Jumper Settings	64
Table 4-5: LVDS Panel Resolution Selection.....	66

List of BIOS Menus

BIOS Menu 1: Main	78
BIOS Menu 2: Advanced	79
BIOS Menu 3: CPU Configuration	80
BIOS Menu 4: PCH-FW Configuration	82
BIOS Menu 5: Trusted Computing	83
BIOS Menu 6: ACPI Settings	84
BIOS Menu 7: RTC Wake Settings	85
BIOS Menu 8: iWDD H/W Monitor	86
BIOS Menu 9: Smart Fan Mode Configuration	87
BIOS Menu 10: F81866 Super IO Configuration	89
BIOS Menu 11: Serial Port n Configuration	90
BIOS Menu 12: Serial Port Console Redirection	91
BIOS Menu 13: Legacy Console Redirection Settings	92
BIOS Menu 14: Console Redirection Settings	93
BIOS Menu 15: USB Configuration	95
BIOS Menu 16: CSM Configuration.....	96
BIOS Menu 17: NVMe Configuration.....	97
BIOS Menu 18: IEI Feature	98
BIOS Menu 19: Chipset	99
BIOS Menu 20: System Agent (SA) Configuration	99
BIOS Menu 21: Memory Configuration.....	100
BIOS Menu 22: Graphics Configuration	101
BIOS Menu 23: PCH-IO Configuration	103
BIOS Menu 24: PCI Express Configuration	105
BIOS Menu 25: M2_A1 / MINI_PCIE1 / M2_M2 Configuration.....	105
BIOS Menu 26: SATA and RST Configuration	107
BIOS Menu 27: Security	109
BIOS Menu 28: Boot	110
BIOS Menu 29: Exit.....	112

Chapter

1

Introduction

1.1 Introduction

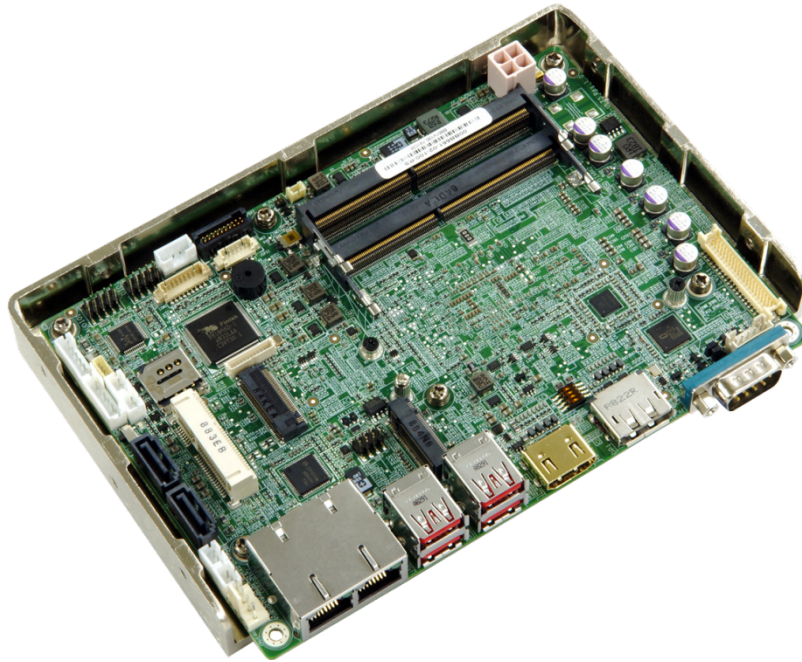

Figure 1-1: NANO-ULT5

The NANO-ULT5 series is an EPIC form factor single board computer. It has an on-board 8th generation 14nm Intel® Core™ i7/i5/i3 or Celeron® processor, and supports two 260-pin 2133/2400 MHz dual-channel DDR4 SDRAM SO-DIMM slots with up to 32.0 GB of memory.

The NANO-ULT5 series includes a DisplayPort connector, a HDMI connector and an 18-/24-bit LVDS connector for triple independent display.

Expansion and I/O include one full-size PCIe Mini slot supporting 3G/4G modules, one M.2 A-key slot and one M.2 M-key slot for expansions, four USB 3.2 Gen 2 (10Gb/s) connectors on the rear panel, two USB 2.0 connectors by pin header and two SATA 6Gb/s connectors. Serial device connectivity is provided by one external RS-232 connector, one internal RS-232 connector and one internal RS-422/485 connector. Two RJ-45 GbE connectors provide the system with smooth connections to an external LAN. One on-board SIM card socket also supports for 3G/LTE expansion.

NANO-ULT5 SBC

1.2 Model Variations

The model variations of the NANO-ULT5 series are listed below.

Model No.	SoC	M.2 SSD
NANO-ULT5-i7	Intel® Core™ i7-8665UE on-board SoC (1.9 GHz, quad-core, 8 MB cache, TDP=15 W)	Supported
NANO-ULT5-i5	Intel® Core™ i5-8365UE on-board SoC (1.6 GHz, quad-core, 6 MB cache, TDP=15 W)	Supported
NANO-ULT5-i3	Intel® Core™ i3-8145UE on-board SoC (2.1 GHz, dual-core, 4 MB cache, TDP=15 W)	Supported
NANO-ULT5-C	Intel® Celeron® 4305UE on-board SoC (2.2 GHz, dual-core, 2 MB cache, TDP=15 W)	PCIe interface only

Table 1-1: NANO-ULT5 Model Variations

1.3 Features

Some of the NANO-ULT5 motherboard features are listed below:

- Thin EPIC motherboard with 8th generation Intel® ULT processor
- Triple independent display
- Two 260-pin 2133/2400 MHz dual-channel DDR4 SO-DIMM slots (system max. 32 GB)
- Easy assembly heat spreader for thermal management
- One M.2 2230 A-key slot and one M.2 2280 M-key slot for function expansions
- Full-size PCIe Mini card slot with SIM card socket for 3G/LTE expansion
- Two SATA 6Gb/s connectors with power output
- Four USB 3.2 Gen 2 (10Gb/s) external connectors
- Two RS-232 connectors and one RS-422/485 connector
- Optional eMMC 5.1

1.4 Connectors

The connectors on the NANO-ULT5 are shown in the figure below.

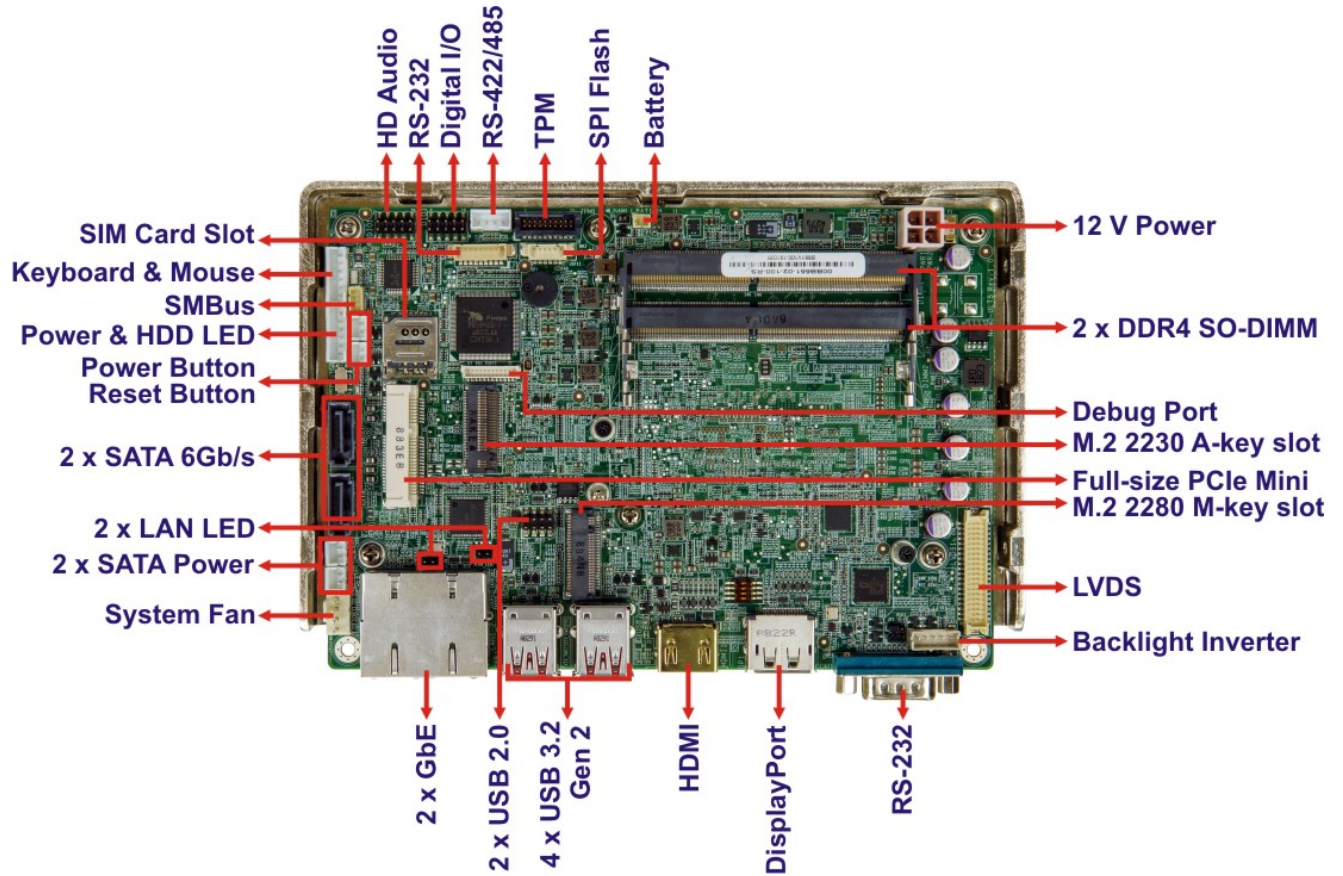

Figure 1-2: Connectors

NANO-ULT5 SBC

1.5 Dimensions

The dimensions of the board are listed below:

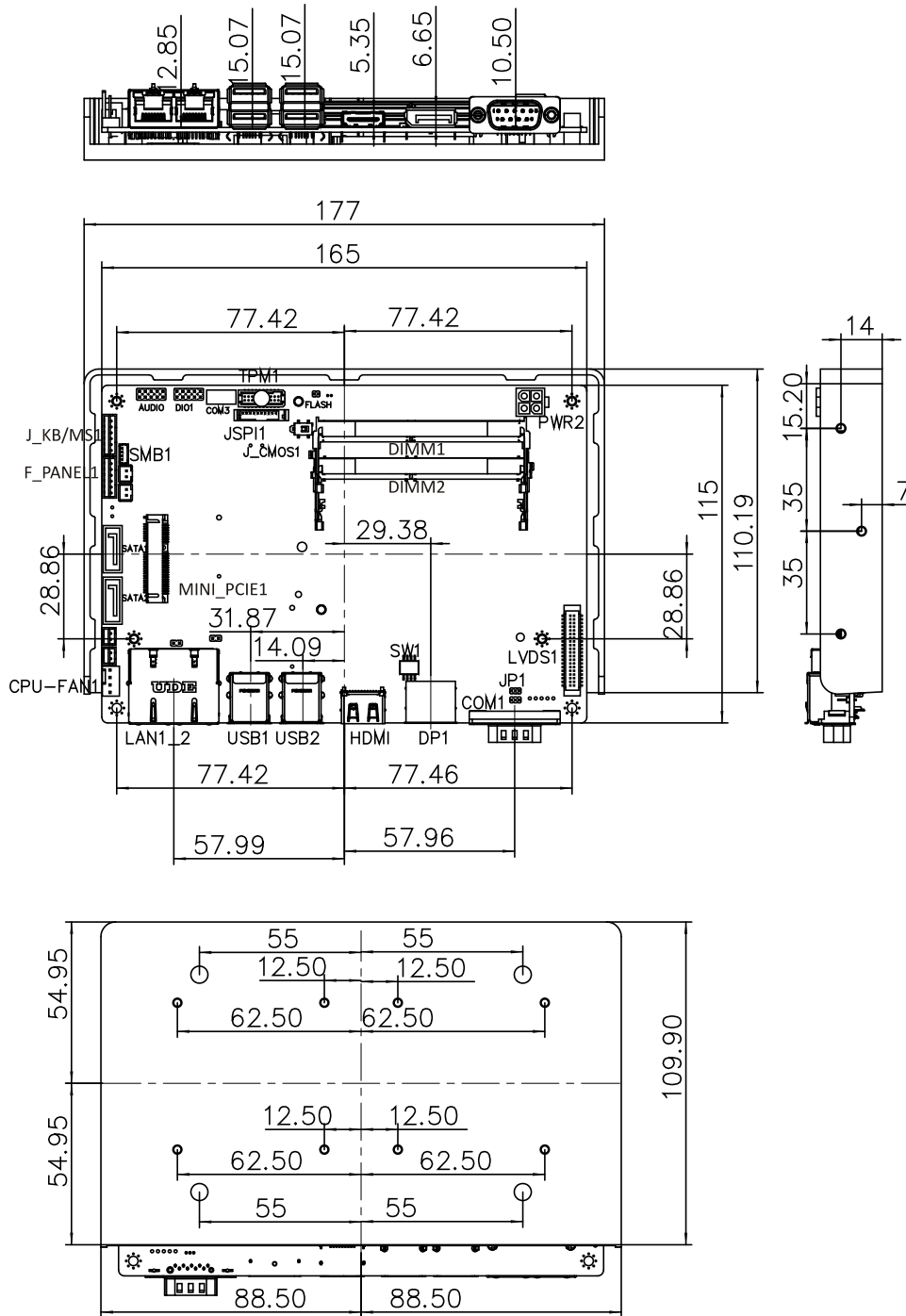

Figure 1-3: Dimensions (mm)

1.6 Data Flow

Figure 1-4 shows the data flow between the system chipset, the CPU and other components installed on the motherboard.

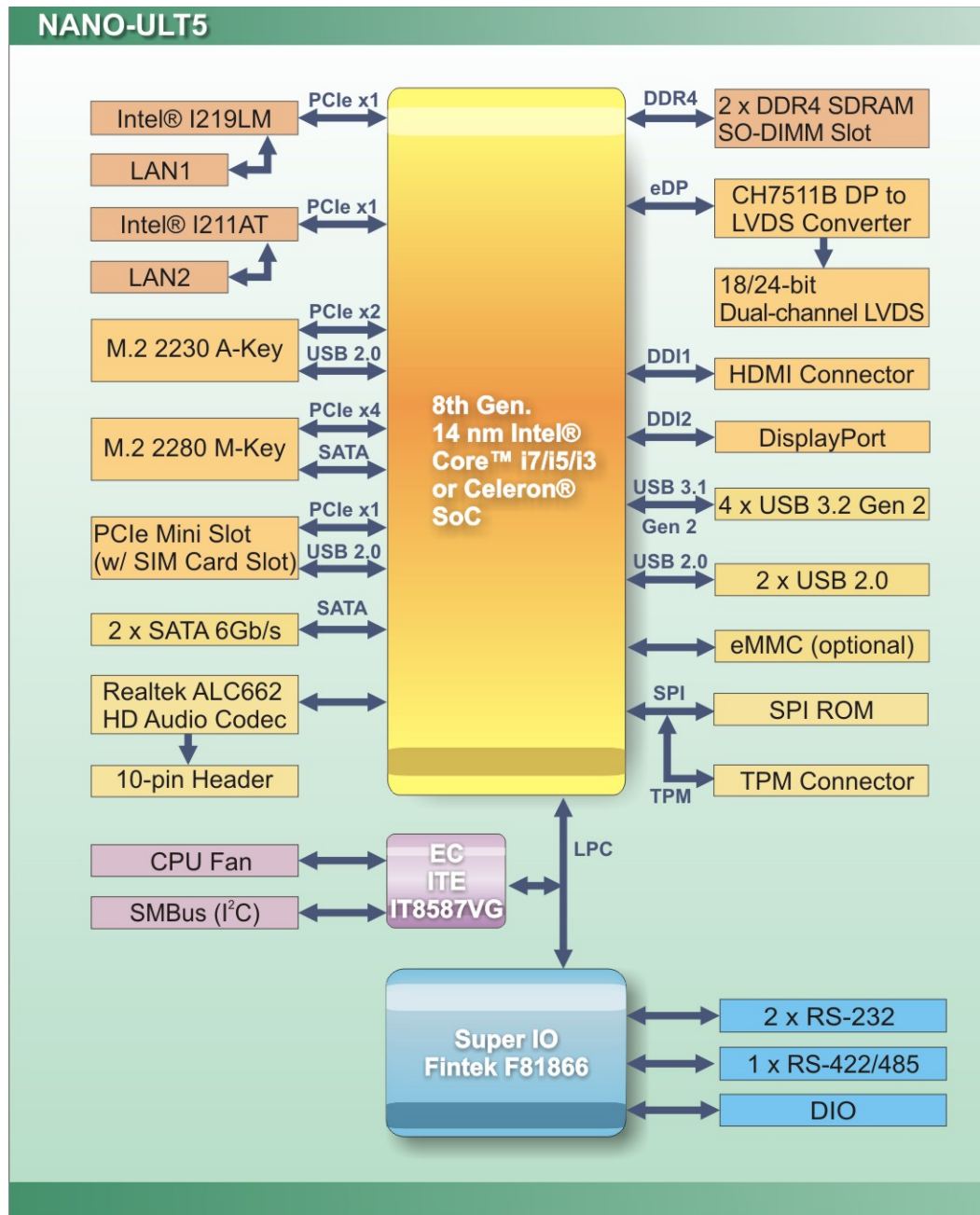

Figure 1-4: Data Flow Diagram

NANO-ULT5 SBC

1.7 Technical Specifications

NANO-ULT5 technical specifications are listed below.

Specification	NANO-ULT5
SoC	8 th generation Intel [®] mobile ULT on-board SoC: <ul style="list-style-type: none"> ▪ Intel[®] Core™ i7-8665UE on-board SoC (1.9 GHz, quad-core, 8 MB cache, TDP=15 W) ▪ Intel[®] Core™ i5-8365UE on-board SoC (1.6 GHz, quad-core, 6 MB cache, TDP=15 W) ▪ Intel[®] Core™ i3-8145UE on-board SoC (2.1 GHz, dual-core, 4 MB cache, TDP=15 W) ▪ Intel[®] Celeron[®] 4305UE on-board SoC (2.2 GHz, dual-core, 2 MB cache, TDP=15 W)
BIOS	AMI UEFI BIOS
Memory	Two 260-pin 2133/2400 MHz dual-channel DDR4 SO-DIMM slots (system max. 32 GB)
Graphics	9 th generation Intel [®] HD Graphics with 16 low-power execution units, 4K codec decode
Display Output	Triple independent display 1 x HDMI (up to 3840x2160 @ 60Hz) 1 x DisplayPort (up to 3840x2160 @ 60Hz) 1 x 18/24-bit dual-channel LVDS by CH7511B DP to LVDS converter (up to 1920x1200 @ 60Hz)
Ethernet	LAN1: Intel [®] I219-LM PHY LAN2: Intel [®] I211-AT PCIe GbE controller
Digital I/O	8-bit digital I/O by 10-pin (2x5) header
Super IO	Fintek F81866D-I
Embedded Controller	ITE IT8587VG
Audio	Realtek ALC662 HD codec
Watchdog Timer	Software programmable support 1~255 sec. system reset

Specification	NANO-ULT5
I/O Interface	
Audio Connector	1 x Analog audio by 10-pin (2x5) header
Ethernet	2 x RJ-45 GbE port
Keyboard/Mouse	1 x KB/MS by 6-pin (1x6) wafer
Serial Ports	1 x RS-232 by 9-pin (1x9) wafer 1 x RS-422/485 by 4-pin (1x4) wafer
USB Ports	4 x USB 3.2 Gen 2 (10Gb/s) on rear I/O 2 x USB 2.0 by 8-pin (2x4) header
Front Panel	1 x Power LED and HDD LED connector by 6-pin (1x6) wafer 1 x Power button connector by 2-pin wafer 1 x Reset button connector by 2-pin wafer
LAN LED	2 x LAN link LED connector by 2-pin header
Fan	1 x Smart fan connector by 4-pin (1x4) wafer
SMBus/I²C	1 x SMBus/I ² C connector by 4-pin (1x4) wafer
Storage	2 x SATA 6Gb/s with 5 V SATA power connectors Optional eMMC
Expansions	1 x M.2 2230 slot (A-key, USB 2.0 + PCIe x2 signals) 1 x M.2 2280 slot (M-key, PCIe x4 + SATA* signal) 1 x Full-size PCIe Mini card slot (PCIe x1 + USB 2.0 signals, with SIM card socket) * The NANO-ULT5-C SKU with Intel® Celeron® 4305UE CPU only supports M.2 SSD modules with PCIe interface.
Environmental and Power Specifications	
Power Supply	12 V DC input only (AT/ATX support)
Power Connector	1 x Internal power connector by 4-pin (2x2) connector
Power Consumption	12V@6.62A (Intel® Core™ i7-8665UE CPU with two 16 GB 2666 MHz DDR4 memory modules)
Operating Temperature	-20°C ~ 60°C

NANO-ULT5 SBC

Specification	NANO-ULT5
Storage Temperature	-30°C ~ 70°C
Humidity	5% ~ 95%, non-condensing
Physical Specifications	
Dimensions	115 mm x 165 mm
Weight GW/NW	850 g / 350 g

Table 1-2: Technical Specifications

Chapter

2

Unpacking

NANO-ULT5 SBC

2.1 Anti-static Precautions



WARNING!

Static electricity can destroy certain electronics. Make sure to follow the ESD precautions to prevent damage to the product, and injury to the user.

Make sure to adhere to the following guidelines:

- **Wear an anti-static wristband:** Wearing an anti-static wristband can prevent electrostatic discharge.
- **Self-grounding:** Touch a grounded conductor every few minutes to discharge any excess static buildup.
- **Use an anti-static pad:** When configuring any circuit board, place it on an anti-static mat.
- **Only handle the edges of the PCB:** Don't touch the surface of the motherboard. Hold the motherboard by the edges when handling.

2.2 Unpacking Precautions

When the NANO-ULT5 is unpacked, please do the following:

- Follow the antistatic guidelines above.
- Make sure the packing box is facing upwards when opening.
- Make sure all the packing list items are present.







2.3 Packing List



NOTE:

If any of the components listed in the checklist below are missing, do not proceed with the installation. Contact the IEI reseller or vendor the NANO-ULT5 was purchased from or contact an IEI sales representative directly by sending an email to sales@ieiworld.com.

The NANO-ULT5 is shipped with the following components:



Quantity	Item and Part Number	Image
1	NANO-ULT5 single board computer	
1	Audio cable	
1	Power cable	
1	RS-232 cable	
1	RS-422/485 cable	
1	SATA with power cable kit	

NANO-ULT5 SBC

1	Quick Installation Guide	
---	--------------------------	---

2.4 Optional Items

The following are optional components which may be separately purchased:

Item and Part Number	Image
KB/MS PS/2 Y-cable, 135 mm, p=2.0 (P/N: 32000-023800-RS)	
Dual USB cable (wo bracket), 210 mm, p=2.0 (P/N: 32000-070301-RS)	
20-pin Infineon TPM 2.0 module, software management tool, firmware v7.63 (P/N: TPM-IN03-R10)	

Chapter

3

Connectors

NANO-ULT5 SBC

3.1 Peripheral Interface Connectors

This chapter details all the jumpers and connectors.

3.1.1 NANO-ULT5 Layout

The figures below show all the connectors and jumpers.

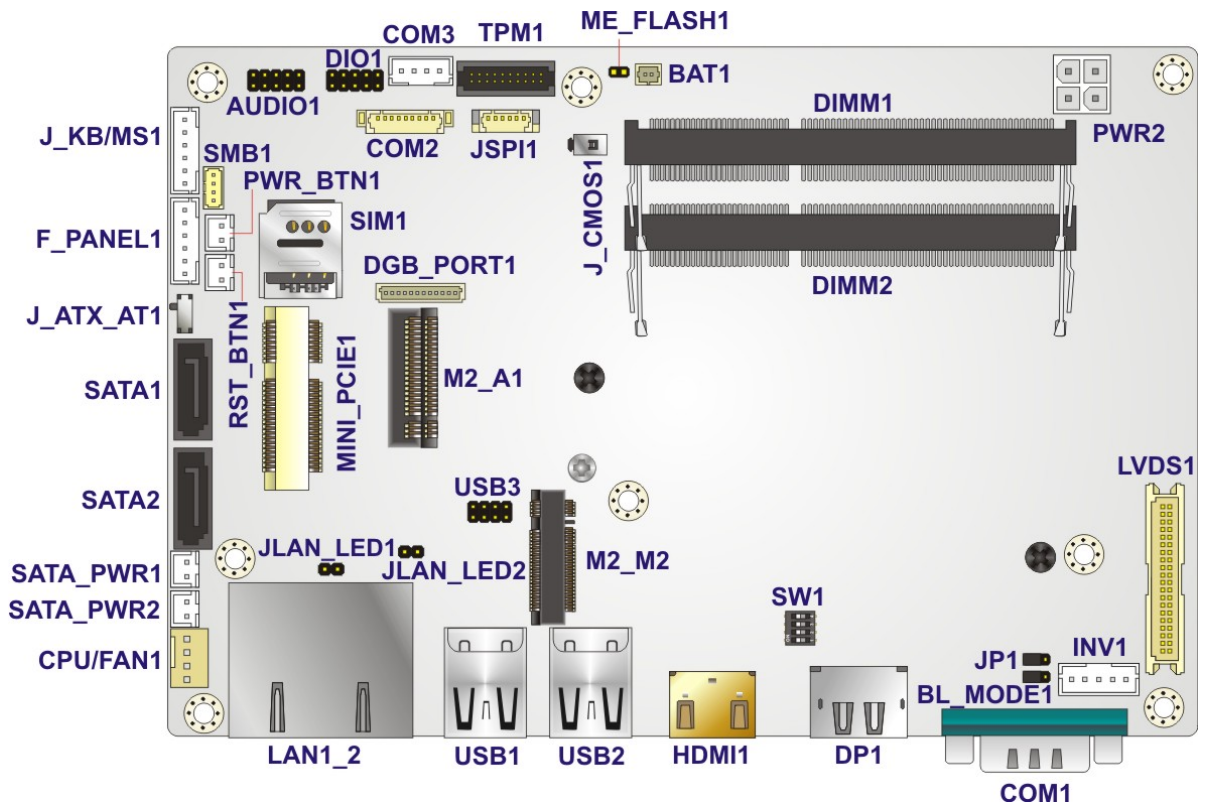

Figure 3-1: Connector and Jumper Locations

3.1.2 Peripheral Interface Connectors

The table below lists all the connectors on the board.

Connector	Type	Label
Audio connector	10-pin header	AUDIO1
Battery connector	2-pin wafer	BAT1
Debug port	12-pin wafer	DBG_PORT1
Digital I/O connector	10-pin header	DIO1
Fan connector	4-pin wafer	CPU/FAN1
Front panel connector	6-pin wafer	F_PANEL1
Keyboard/Mouse connector	6-pin wafer	J_KB/MS1
LAN LED connector	2-pin header	JLAN_LED1, JLAN_LED2
LVDS connector	40-pin crimp	LVDS1
LVDS backlight connector	5-pin wafer	INV1
M.2 2230 A-key slot	M.2 A-key slot	M2_A1
M.2 2280 M-key slot	M.2 M-key slot	M2_M2
Memory module slots	260-pin DDR4 SO-DIMM	DIMM1, DIMM2
PCIe Mini card slot	Full-size PCIe Mini slot	MINI_PCIE1
Power connector	4-pin Molex	PWR2
Power button connector	2-pin wafer	PWR_BTN1
Reset button connector	2-pin wafer	RST_BTN1
RS-232 serial port connector	9-pin wafer	COM2
RS-422/485 serial port connector	4-pin wafer	COM3
Serial ATA connector	7-pin SATA connector	SATA1, SATA2
SATA power connector	2-pin wafer	SATA_PWR1, SATA_PWR2

NANO-ULT5 SBC

SMBus/I ² C connector	4-pin wafer	SMB1
SIM card holder	Push-pull SIM slot	SIM1
SPI flash connector	6-pin wafer	JSPI1
TPM module connector	20-pin box header	TPM1
USB 2.0 connector	8-pin header	USB3

Table 3-1: Peripheral Interface Connectors

3.1.3 External Interface Panel Connectors

The table below lists the connectors on the external I/O panel.

Connector	Type	Label
DisplayPort connector	DisplayPort	DP1
HDMI connector	HDMI	HDMI1
LAN connectors	RJ-45	LAN1_2
RS-232 connector	DB-9	COM1
USB 3.2 Gen 2 connectors	USB 3.2 Gen 2	USB1, USB2

Table 3-2: Rear Panel Connectors

3.2 Internal Peripheral Connectors

The section describes all of the connectors on the NANO-ULT5.

3.2.1 Audio Connector

- CN Label:** AUDIO1
- CN Type:** 10-pin header, p=2.00 mm
- CN Location:** See **Figure 3-2**
- CN Pinouts:** See **Table 3-3**

The audio connector is connected to external audio devices including speakers and microphones for the input and output of audio signals to and from the system.

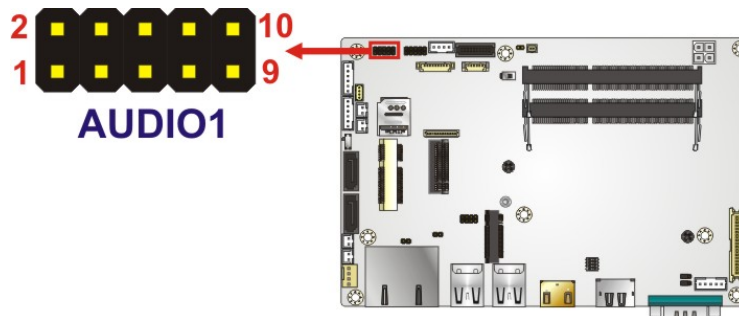

Figure 3-2: Audio Connector Location

PIN NO.	DESCRIPTION	PIN NO.	DESCRIPTION
1	LINE_OUT_R	2	LINE-IN_R
3	AUD_GND	4	AUD_GND
5	LINE_OUT_L	6	LINE-IN_L
7	AUD_GND	8	AUD_GND
9	MIC1_R	10	MIC1_L

Table 3-3: Audio Connector Pinouts

NANO-ULT5 SBC

3.2.2 Battery Connector



CAUTION:

Risk of explosion if battery is replaced by an incorrect type. Only certified engineers should replace the on-board battery.

Dispose of used batteries according to instructions and local regulations.



NOTE:

It is recommended to attach the RTC battery onto the system chassis in which the NANO-ULT5 is installed.

CN Label:	BAT1
CN Type:	2-pin wafer, p=1.25 mm
CN Location:	See Figure 3-3
CN Pinouts:	See Table 3-4

The battery connector is connected to the system battery. The battery provides power to the system clock to retain the time when power is turned off.

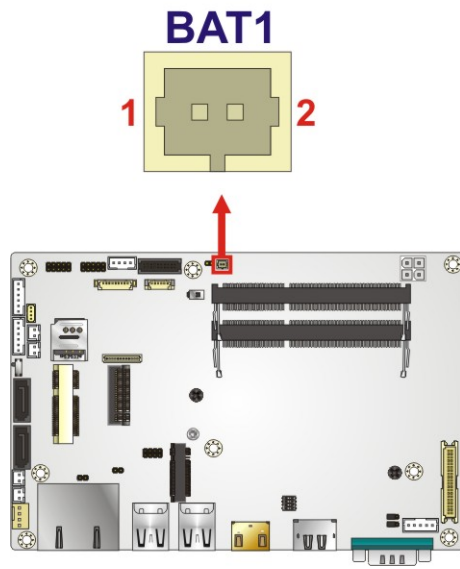

Figure 3-3: Battery Connector Location

Pin	Description
1	VBAT+
2	GND

Table 3-4: Battery Connector Pinouts

NANO-ULT5 SBC

3.2.3 Digital I/O Connector

- CN Label:** DIO1
- CN Type:** 10-pin header, p=2.00 mm
- CN Location:** See **Figure 3-4**
- CN Pinouts:** See **Table 3-5**

The 8-bit digital I/O connector provides programmable input and output for external devices.

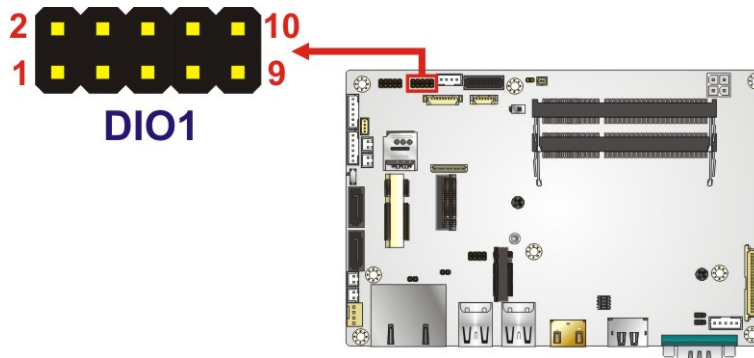

Figure 3-4: Digital I/O Connector Location

PIN NO.	DESCRIPTION	PIN NO.	DESCRIPTION
1	GND	2	+5V
3	DOUT3	4	DOUT2
5	DOUT1	6	DOUT0
7	DIN3	8	DIN2
9	DIN1	10	DIN0

Table 3-5: Digital I/O Connector Pinouts

3.2.4 Fan Connector

- CN Label:** CPU/FAN1
- CN Type:** 4-pin wafer, p=2.54 mm
- CN Location:** See **Figure 3-5**
- CN Pinouts:** See **Table 3-6**

The fan connector attaches to a smart cooling fan.

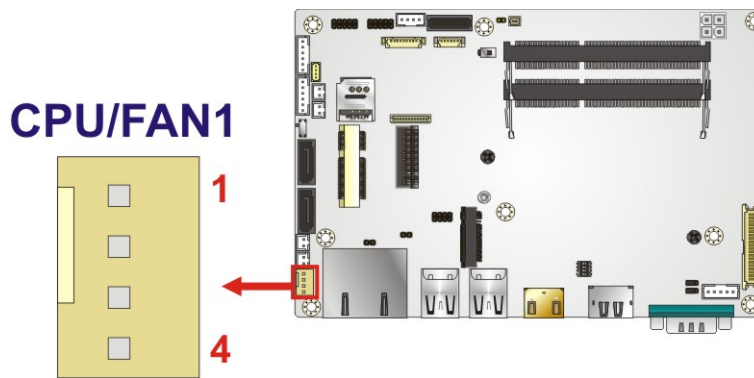

Figure 3-5: Fan Connector Location

Pin	Description
1	GND
2	+12V
3	Rotation Signal
4	PWM Control Signal

Table 3-6: Fan Connector Pinouts

NANO-ULT5 SBC

3.2.5 Front Panel Connector

- CN Label:** F_PANEL1
- CN Type:** 6-pin wafer, p=2.00 mm
- CN Location:** See **Figure 3-6**
- CN Pinouts:** See **Table 3-7**

The front panel connector connects to the power LED indicator and HDD LED indicator on the system front panel.

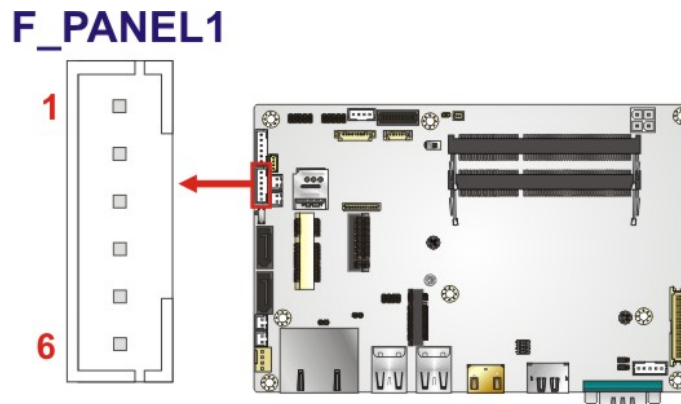

Figure 3-6: Front Panel Connector Location

Pin	Description
1	VCC
2	GND
3	PWR_LED+
4	PWR_LED-
5	HDD_LED+
6	HDD_LED-

Table 3-7: Front Panel Connector Pinouts

3.2.6 Keyboard and Mouse Connector

- CN Label:** J_KB/MS1
- CN Type:** 6-pin wafer, p=2.00 mm
- CN Location:** See **Figure 3-7**
- CN Pinouts:** See **Table 3-8**

The keyboard/mouse connector connects to a PS/2 Y-cable that can be connected to a PS/2 keyboard and mouse.

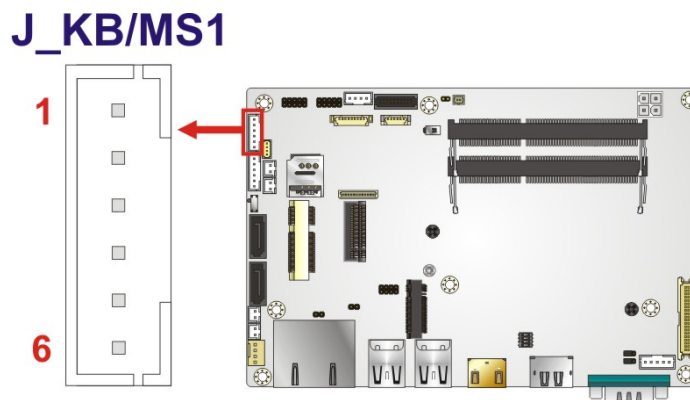

Figure 3-7: Keyboard and Mouse Connector Location

Pin	Description
1	VCC5V
2	Mouse Data
3	Mouse Clock
4	Keyboard Data
5	Keyboard Clock
6	GND

Table 3-8: Keyboard and Mouse Connector Pinouts

NANO-ULT5 SBC

3.2.7 LAN LED Connectors

CN Label: JLAN_LED1, JLAN_LED2

CN Type: 2-pin header, p=2.00 mm

CN Location: See **Figure 3-8**

CN Pinouts: See **Table 3-9**

The LAN LED connectors connect to the LAN link LEDs on the system.

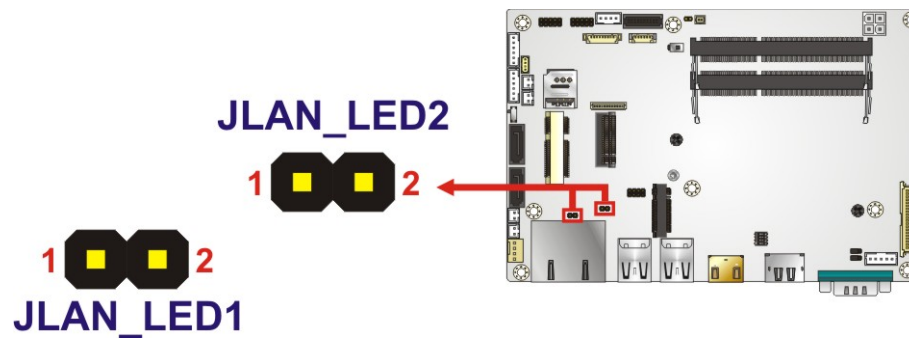

Figure 3-8: LAN LED Connector Locations

Pin	Description
1	+3.3VLAN
2	LAN_LED_LINK#

Table 3-9: LAN LED Connector Pinouts

3.2.8 LVDS LCD Connector

CN Label: LVDS1

CN Type: 40-pin crimp, p=1.25 mm

CN Location: See **Figure 3-9**

CN Pinouts: See **Table 3-10**

The LVDS connector is for an LCD panel to connect to the board.

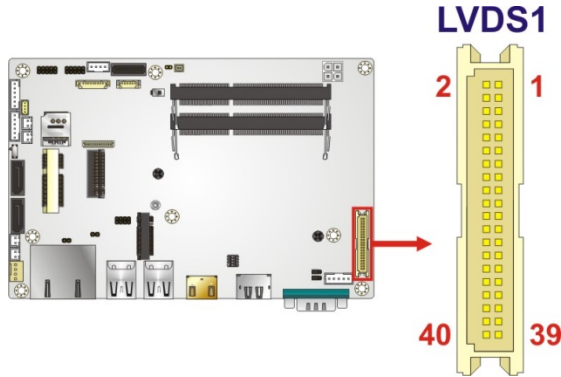

Figure 3-9: LVDS Connector Location



NOTE:

To use LVDS, the #33 pin of LVDS1 connector must be connected with GND pin; otherwise the LVDS panel will not be detected, or fail to display.

Pin	Description	Pin	Description
1	GROUND	2	GROUND
3	LVDS_A_TX0-N	4	LVDS_A_TX1-N
5	LVDS_A_TX0-P	6	LVDS_A_TX1-P
7	GROUND	8	GROUND
9	LVDS_A_TX2-N	10	LVDS_A_TXCLK-N
11	LVDS_A_TX2-P	12	LVDS_A_TXCLK-P
13	GROUND	14	GROUND
15	LVDS_A_TX3-N	16	LVDS_B_TX0-N
17	LVDS_A_TX3-P	18	LVDS_B_TX0-P
19	GROUND	20	GROUND
21	LVDS_B_TX1-N	22	LVDS_B_TX2-N
23	LVDS_B_TX1-P	24	LVDS_B_TX2-P
25	GROUND	26	GROUND
27	LVDS_B_TXCLK-N	28	LVDS_B_TX3-N
29	LVDS_B_TXCLK-P	30	LVDS_B_TX3-P
31	GROUND	32	GROUND

NANO-ULT5 SBC

Pin	Description	Pin	Description
33	LVDS Detect (GND)*	34	GROUND
35	+LCD VCC	36	+LCD VCC
37	+LCD VCC	38	+LCD VCC
39	+LCD VCC	40	+LCD VCC

***LVDS Detect must be connected to GND.**

Table 3-10: LVDS Connector Pinouts

3.2.9 LVDS Backlight Inverter Connector

- CN Label:** INV1
- CN Type:** 5-pin wafer, p=2.00 mm
- CN Location:** See **Figure 3-10**
- CN Pinouts:** See **Table 3-11**

The backlight inverter connector provides power to an LCD panel.

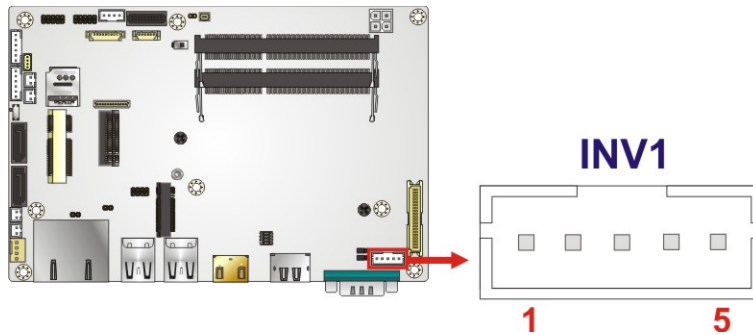

Figure 3-10: Backlight Inverter Connector Location

Pin	Description
1	LCD_BKLTCTL
2	GND
3	+12V
4	GND
5	BACKLIGHT_ENABLE

Table 3-11: Backlight Inverter Connector Pinouts

3.2.10 M.2 Slot, A-key

- CN Label:** M2_A1
- CN Type:** M.2 A-key slot
- CN Location:** See **Figure 3-11**
- CN Pinouts:** See **Table 3-12**

The M.2 slot is keyed in the A position and accepts 2230 size of M.2 modules. The M.2 slot supports PCIe x2 and USB 2.0 signals.

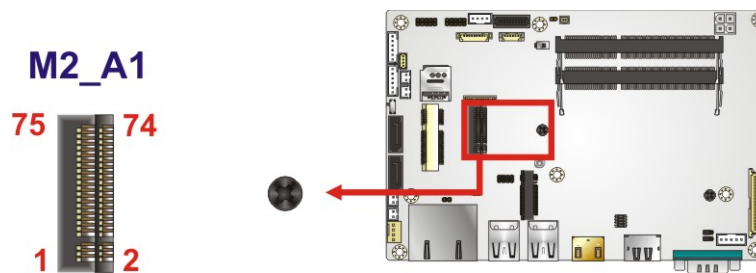

Figure 3-11: M.2 A-key Slot Location

Pin	Description	Pin	Description
1	GND	2	+V3.3A
3	USB+	4	+V3.3A
5	USB-	6	NC
7	GND	8	Module Key
9	Module Key	10	Module Key
11	Module Key	12	Module Key
13	Module Key	14	Module Key
15	Module Key	16	NC
17	NC	18	GND
19	NC	20	NC
21	NC	22	NC
23	GND	24	GND
25	NC	26	NC
27	NC	28	NC
29	GND	30	GND

NANO-ULT5 SBC

Pin	Description	Pin	Description
31	NC	32	NC
33	GND	34	NC
35	PCIE_TX0+	36	GND
37	PCIE_TX0-	38	NC
39	GND	40	NC
41	PCIE_RX0+	42	NC
43	PCIE_RX0-	44	NC
45	GND	46	NC
47	CLK_PCIE0+	48	NC
49	CLK_PCIE0-	50	NC
51	GND	52	BUF_PLT_RST#
53	PCIE_CLKREQ#	54	Pull Up +V3.3A
55	PCIE_WAKE#	56	Pull Up +V3.3A
57	GND	58	NC
59	PCIE_TX1+	60	NC
61	PCIE_TX1-	62	NC
63	GND	64	NC
65	PCIE_RX1+	66	NC
67	PCIE_RX1-	68	NC
69	GND	70	NC
71	CLK_PCIE1+	72	+V3.3A
73	CLK_PCIE1-	74	+V3.3A
75	GND		

Table 3-12: M.2 A-Key Slot Pinouts

3.2.11 M.2 Slot, M-key

- CN Label:** M2_M2
- CN Type:** M.2 M-key slot
- CN Location:** See **Figure 3-12**
- CN Pinouts:** See **Table 3-13**

The M.2 slot is keyed in the M position and accepts 2280 size of M.2 modules. The M.2 slot supports PCIe x4 and SATA signals.



NOTE:

The NANO-ULT5-C SKU with Intel® Celeron® 4305UE CPU only supports M.2 SSD modules with PCIe interface.

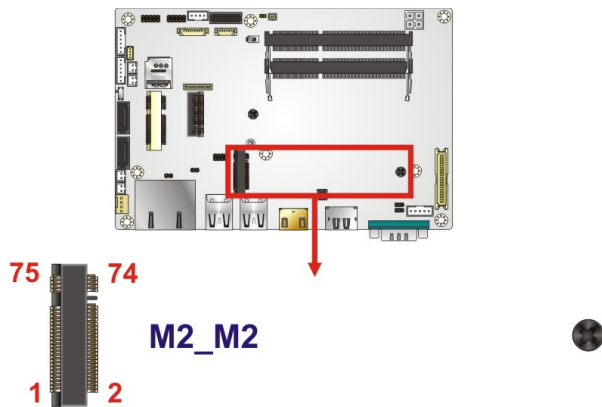

Figure 3-12: M.2 M-key Slot Location

Pin	Description	Pin	Description
1	GND	2	+3.3V
3	GND	4	+3.3V
5	PCIE_RXN3	6	N/C
7	PCIE_RXP3	8	N/C
9	GND	10	DAS/DSS#
11	PCIE_TXN3	12	+3.3V
13	PCIE_TXP3	14	+3.3V

NANO-ULT5 SBC

Pin	Description	Pin	Description
15	GND	16	+3.3V
17	PCIE_RXN2	18	+3.3V
19	PCIE_RXP2	20	N/C
21	GND	22	N/C
23	PCIE_TXN2	24	N/C
25	PCIE_TXP2	26	N/C
27	GND	28	N/C
29	PCIE_RXN1	30	N/C
31	PCIE_RXP1	32	N/C
33	GND	34	N/C
35	PCIE_TXN1	36	N/C
37	PCIE_TXP1	38	DEVSLP
39	GND	40	N/C
41	PCIE_RXN0	42	N/C
43	PCIE_RXP0	44	N/C
45	GND	46	N/C
47	PCIE_TXN0	48	N/C
49	PCIE_TXP0	50	PERST#
51	GND	52	CLKREQ#
53	REFCLKN	54	PEWAKE
55	REFCLKP	56	N/C
57	GND	58	N/C
59	Module Key	60	Module Key
61	Module Key	62	Module Key
63	Module Key	64	Module Key
65	Module Key	66	Module Key
67	N/C	68	SUSCLK
69	PEDET	70	+3.3V
71	GND	72	+3.3V
73	GND	74	+3.3V
75	GND		

Table 3-13: M.2 M-Key Slot Pinouts

3.2.12 DDR4 SO-DIMM Sockets



CAUTION:

For dual channel configuration, always install two identical memory modules that feature the same capacity, timings, voltage, number of ranks and the same brand.

CN Label:	DIMM1, DIMM2
CN Type:	260-pin DDR4 SO-DIMM socket
CN Location:	See Figure 3-13

The SO-DIMM slots are for installing the DDR4 SO-DIMMs.

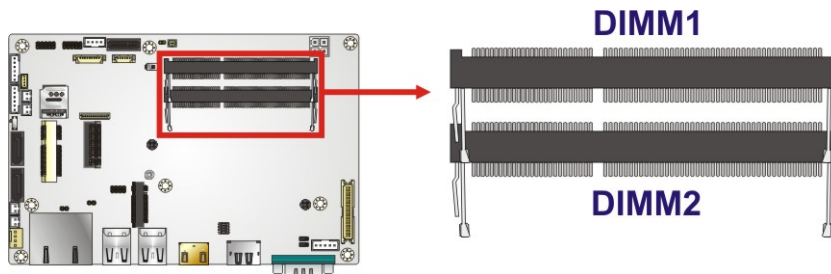

Figure 3-13: DDR4 SO-DIMM Socket Locations

3.2.13 PCIe Mini Card Slot, Full-size

CN Label:	MINI_PCIE1
CN Type:	Full-size PCIe Mini card slot
CN Location:	See Figure 3-14
CN Pinouts:	See Table 3-14

The PCIe Mini card slot supports PCIe Mini cards with USB and PCIe interface such as 3G modules.

NANO-ULT5 SBC

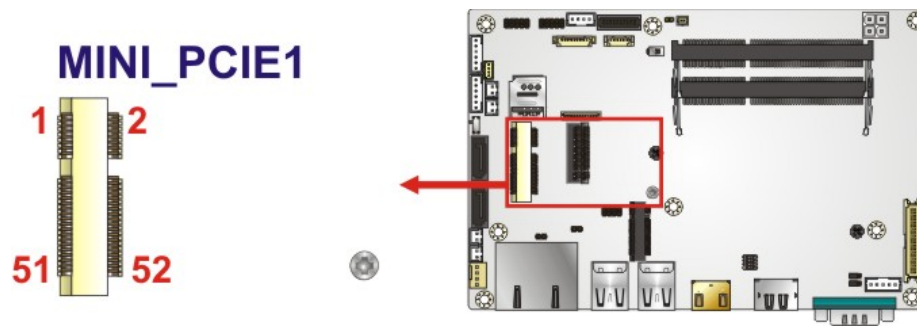

Figure 3-14: Full-size PCIe Mini Card Slot Location

Pin	Description	Pin	Description
1	PCIE_WAKE#	2	VCC3
3	N/C	4	GND
5	N/C	6	1.5V
7	N/C	8	SIM_PWR
9	GND	10	SIM_DATA
11	PCIE_CLK#	12	SIM_CLK
13	PCIE_CLK	14	SIM_RST
15	GND	16	SIM_VPP
17	N/C	18	GND
19	N/C	20	N/C
21	GND	22	PCIRST#
23	PCIE_RXN	24	N/C
25	PCIE_RXP	26	GND
27	GND	28	1.5V
29	GND	30	SMBCLK
31	PCIE_TXN	32	SMBDATA
33	PCIE_TXP	34	GND
35	GND	36	USB D-
37	GND	38	USB D+
39	VCC3	40	GND
41	VCC3	42	N/C
43	GND	44	N/C
45	N/C	46	N/C

Pin	Description	Pin	Description
47	N/C	48	1.5V
49	N/C	50	GND
51	N/C	52	VCC3

Table 3-14: Full-size PCIe Mini Card Slot Pinouts

3.2.14 Power Connector

- CN Label:** PWR2
- CN Type:** 4-pin Molex, p=4.2 mm
- CN Location:** See **Figure 3-15**
- CN Pinouts:** See **Table 3-15**

The connector supports the +12V power supply.

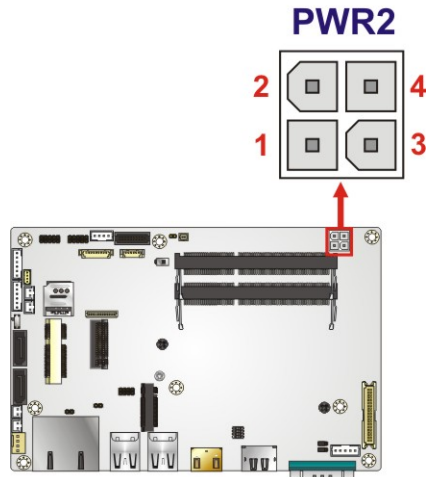

Figure 3-15: +12V DC-IN Power Connector Location

PIN NO.	DESCRIPTION	PIN NO.	DESCRIPTION
1	GND	2	GND
3	+12V	4	+12V

Table 3-15: +12V DC-IN Power Connector Pinouts

NANO-ULT5 SBC

3.2.15 Power Button Connector

- CN Label:** PWR_BTN1
- CN Type:** 2-pin wafer, p=2.00 mm
- CN Location:** See **Figure 3-16**
- CN Pinouts:** See **Table 3-16**

The power button connector is connected to a power switch on the system chassis to enable users to turn the system on and off.

PWR_BTN1

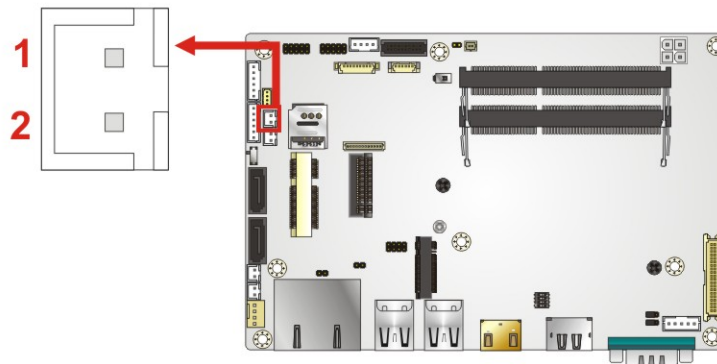

Figure 3-16: Power Button Connector Location

Pin	Description
1	PWR_BTN+
2	PWR_BTN-

Table 3-16: Power Button Connector Pinouts

3.2.16 Reset Button Connector

- CN Label:** RST_BTN1
- CN Type:** 2-pin wafer, p=2.00 mm
- CN Location:** See **Figure 3-17**
- CN Pinouts:** See **Table 3-17**

The reset button connector is connected to a reset switch on the system chassis to enable users to reboot the system when the system is turned on.

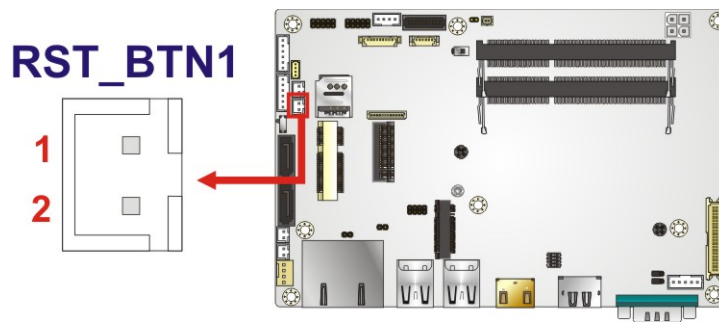

Figure 3-17: Reset Button Connector Location

Pin	Description
1	RESET+
2	RESET-

Table 3-17: Reset Button Connector Pinouts

NANO-ULT5 SBC

3.2.17 RS-232 Serial Port Connector

- CN Label:** COM2
- CN Type:** 9-pin wafer, p=1.25 mm
- CN Location:** See **Figure 3-18**
- CN Pinouts:** See **Table 3-18**

The serial connector provides RS-232 connection.

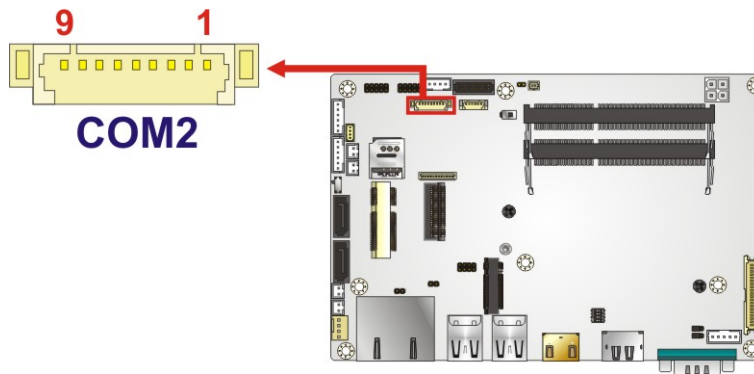

Figure 3-18: RS-232 Serial Port Connector Location

PIN NO.	DESCRIPTION	PIN NO.	DESCRIPTION
1	DCD	2	DSR
3	RXD	4	RTS
5	TXD	6	CTS
7	DTR	8	RI
9	GND		

Table 3-18: RS-232 Serial Port Connector Pinouts

3.2.18 RS-422/485 Serial Port Connector

- CN Label:** COM3
- CN Type:** 4-pin wafer, p=2.00 mm
- CN Location:** See **Figure 3-19**
- CN Pinouts:** See **Table 3-19**

This connector provides RS-422 or RS-485 communications.

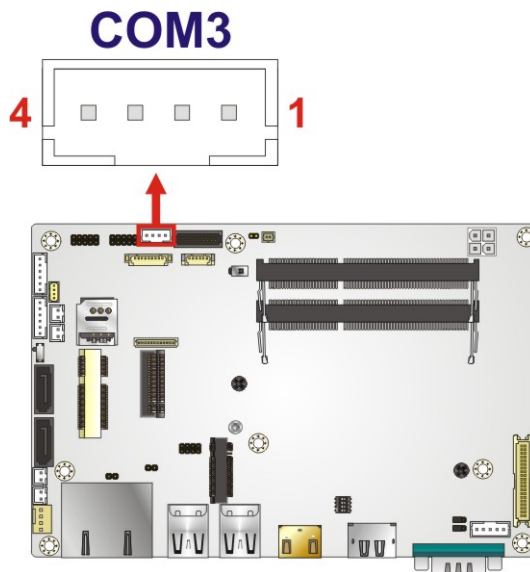

Figure 3-19: RS-422/485 Connector Location

Pin	Description
1	RXD422-
2	RXD422+
3	TXD422+/TXD485+
4	TXD422-/TXD485-

Table 3-19: RS-422/485 Connector Pinouts

NANO-ULT5 SBC

3.2.19 SATA 6Gb/s Drive Connectors

- CN Label:** SATA1, SATA2
- CN Type:** 7-pin SATA connector
- CN Location:** See **Figure 3-20**

The SATA 6Gb/s drive connector is connected to a SATA 6Gb/s drive. The SATA 6Gb/s drive transfers data at speeds as high as 6Gb/s.

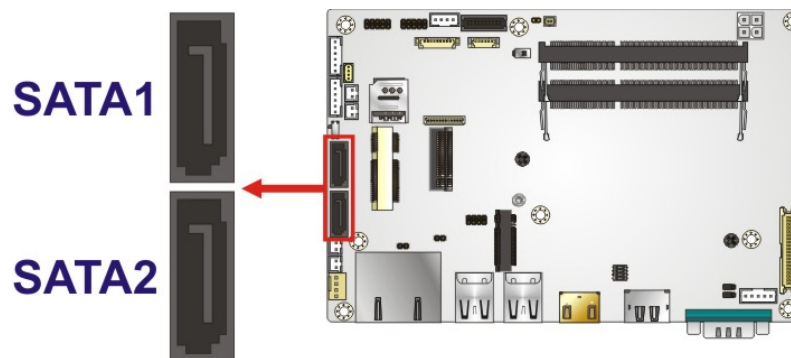

Figure 3-20: SATA 6Gb/s Drive Connectors Locations

3.2.20 SATA Power Connectors

CN Label: SATA_PWR1, SATA_PWR2

CN Type: 2-pin wafer, p=2.00 mm

CN Location: See Figure 3-21

CN Pinouts: See Table 3-20

The SATA power connector provides +5 V power output to the SATA connector.

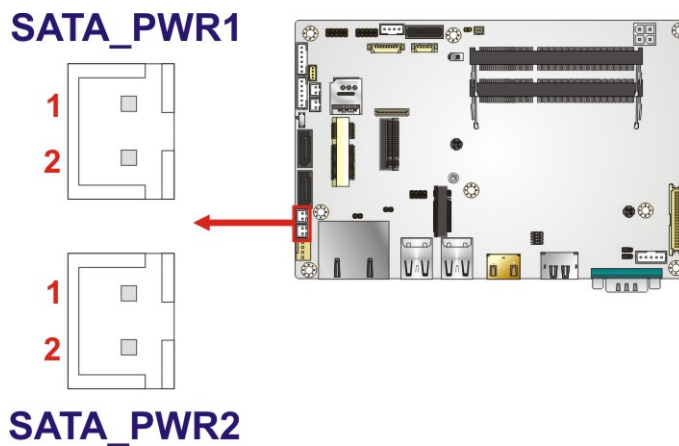

Figure 3-21: SATA Power Connector Locations

Pin	Description
1	+5V
2	GND

Table 3-20: SATA Power Connector Pinouts

NANO-ULT5 SBC

3.2.21 SMBus/I²C Connector

- CN Label:** SMB1
- CN Type:** 4-pin wafer, p=1.25 mm
- CN Location:** See **Figure 3-22**
- CN Pinouts:** See **Table 3-21**

The SMBus (System Management Bus) connector provides low-speed system management communications.

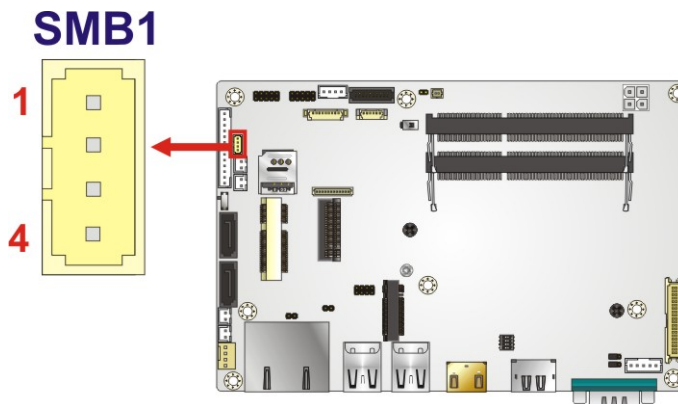

Figure 3-22: SMBus Connector Location

Pin	Description
1	GND
2	SMBus (I ² C) DATA
3	SMBus (I ² C) CLK
4	+5V

Table 3-21: SMBus Connector Pinouts

3.2.22 SIM Card Slot

- CN Label:** SIM1
- CN Type:** SIM card slot
- CN Location:** See **Figure 3-23**

The SIM card slot accepts a SIM card for 3G network communication.



NOTE:

A WWAN module must be installed in the PCIe Mini slot (MINI_PICE1) to provide WWAN communication.

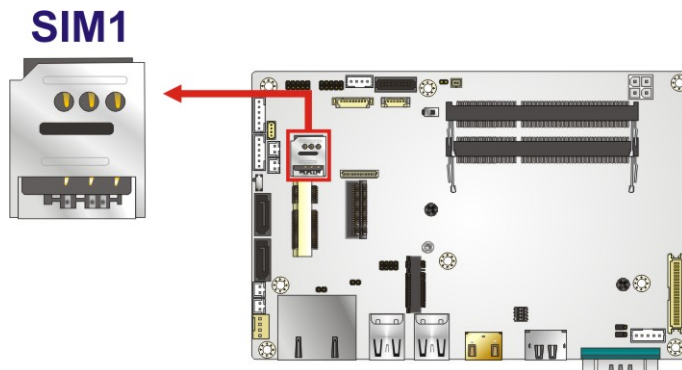

Figure 3-23: SIM Card Slot Location

NANO-ULT5 SBC

3.2.23 SPI Flash Connector

- CN Label:** JSPI1
- CN Type:** 6-pin wafer, p=1.25 mm
- CN Location:** See **Figure 3-24**
- CN Pinouts:** See **Table 3-22**

The 6-pin SPI Flash connector is used to flash the BIOS.

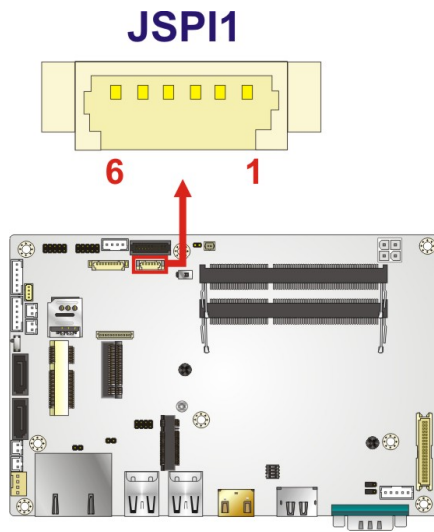

Figure 3-24: SPI Flash Connector Location

Pin	Description
1	+3.3V
2	SPI_CS#_SW
3	SPI_SO_SW
4	SPI_CLK_SW
5	SPI_SI_SW
6	GND

Table 3-22: SPI Flash Connector Pinouts

3.2.24 TPM Connector

- CN Label:** TPM1
- CN Type:** 20-pin box header, p=1.27 mm
- CN Location:** See **Figure 3-25**
- CN Pinouts:** See **Table 3-23**

The Trusted Platform Module (TPM) connector is for TPM module installation.

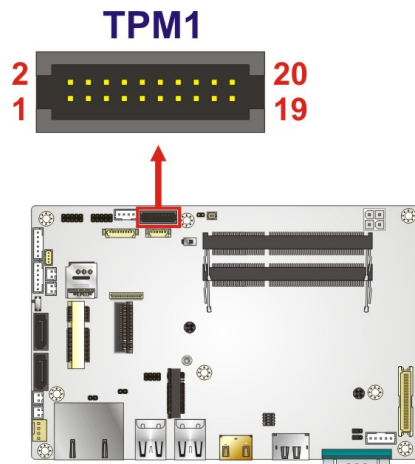

Figure 3-25: TPM Connector Pinout Locations

Pin	Description	Pin	Description
1	NC	2	SPI_CS#_SW
3	TPM_CLK_SW	4	SPI_TPM_CS1
5	GND	6	+3.3V
7	TPM_CLK_SW	8	SPI_TPM_DQ2
9	SPI_TPM_DQ2	10	TPM_SO_SW
11	SPI_TPM_HOLD_N	12	TPM_SI_SW
13	SPI_TPM_CS2	14	GND
15	SPI_TPM_WP	16	SER_IRQ
17	SPI_TPM_INT_N	18	+3.3V
19	PCIE_RST#	20	VCC_SPI_TPM_R

Table 3-23: TPM Connector Pinouts

NANO-ULT5 SBC

3.2.25 USB 2.0 Connector

- CN Label:** USB3
- CN Type:** 8-pin header, p=2.00 mm
- CN Location:** See **Figure 3-26**
- CN Pinouts:** See **Table 3-24**

The USB connector provides two USB 2.0 ports by dual-port USB cable.

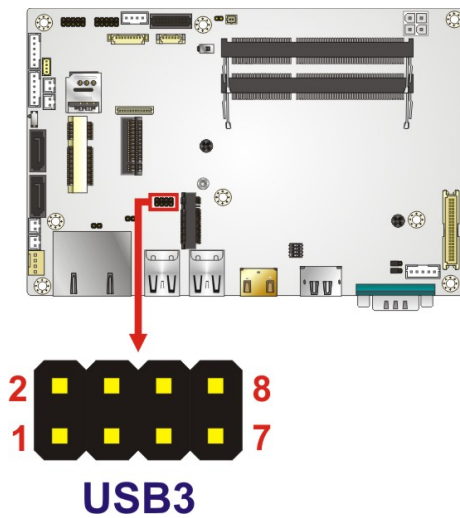

Figure 3-26: USB Connector Location

PIN NO.	DESCRIPTION	PIN NO.	DESCRIPTION
1	VCC	2	GND
3	DATA-	4	DATA+
5	DATA+	6	DATA-
7	GND	8	VCC

Table 3-24: USB Connector Pinouts

3.3 External Peripheral Interface Connector Panel

Figure 3-27 shows the NANO-ULT5 external peripheral interface connector (EPIC) panel. The EPIC panel consists of the following:

- 1 x DisplayPort connector
- 1 x HDMI connector
- 2 x GbE RJ-45 connector
- 1 x RS-232 DB-9 connector
- 4 x USB 3.2 Gen 2 connector

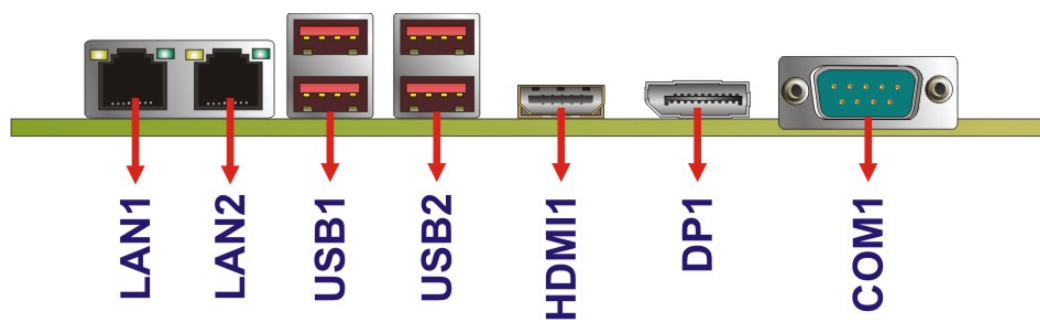

Figure 3-27: External Peripheral Interface Connector

NANO-ULT5 SBC

3.3.1 DisplayPort Connector

- CN Label:** DP1
- CN Type:** DisplayPort
- CN Location:** See **Figure 3-27**
- CN Pinouts:** See **Table 3-25** and **Figure 3-28**

The DisplayPort connector connects to a display device with DisplayPort interface.

Pin	Description	Pin	Description
1	DATA_0P	2	GND
3	DATA_0N	4	DATA_1P
5	GND	6	DATA_1N
7	DATA_2P	8	GND
9	DATA_2N	10	DATA_3P
11	GND	12	DATA_3N
13	CONFIG1	14	CONFIG2
15	AUX_P	16	GND
17	AUX_N	18	DP_HPDP
19	GND	20	DP PWR

Table 3-25: DisplayPort Connector Pinouts

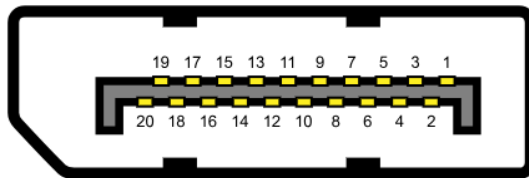

Figure 3-28: DisplayPort Connector Pinout Locations

3.3.2 HDMI Connector

- CN Label:** HDMI1
- CN Type:** HDMI connector
- CN Location:** See **Figure 3-27**
- CN Pinouts:** See **Table 3-26** and **Figure 3-29**

The HDMI connectors can connect to HDMI devices.

Pin	Description	Pin	Description
1	HDMI_DATA2	2	GND
3	HDMI_DATA2#	4	HDMI_DATA1
5	GND	6	HDMI_DATA1#
7	HDMI_DATA0	8	GND
9	HDMI_DATA0#	10	HDMI_CLK
11	GND	12	HDMI_CLK#
13	N/C	14	N/C
15	HDMI_SCL	16	HDMI_SDA
17	GND	18	+5V
19	HDMI_HPD		

Table 3-26: HDMI Connector Pinouts

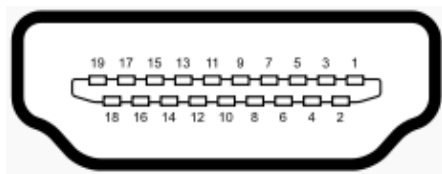

Figure 3-29: HDMI Connector Pinout Locations

NANO-ULT5 SBC

3.3.3 LAN Connectors

- CN Label:** LAN1_2
- CN Type:** RJ-45
- CN Location:** See **Figure 3-27**
- CN Pinouts:** See **Figure 3-30** and **Table 3-27**

The LAN connector connects to a local network.

Pin	Description	Pin	Description
1	MDIA0+	5	MDIA2-
2	MDIA0-	6	MDIA1-
3	MDIA1+	7	MDIA3+
4	MDIA2+	8	MDIA3-

Table 3-27: LAN Pinouts

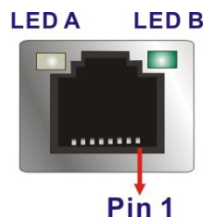

Figure 3-30: LAN Connector

LED	Description	LED	Description
A	off: 10 Mb/s green: 100 Mb/s orange: 1000 Mb/s	B	on: linked blinking: data is being sent/received

Table 3-28: LAN Connector LEDs

3.3.4 RS-232 Serial Port Connector

- CN Label:** COM1
- CN Type:** DB-9 connector
- CN Location:** See Figure 3-27
- CN Pinouts:** See Table 3-29 and Figure 3-31

The serial port connects to a RS-232 serial communications device.

Pin	Description	Pin	Description
1	DCD	6	DSR
2	RX	7	RTS
3	TX	8	CTS
4	DTR	9	RI
5	GND		

Table 3-29: Serial Port Pinouts

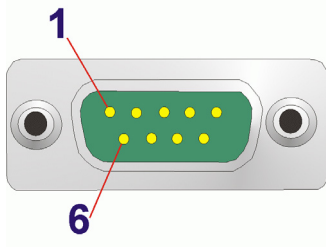

Figure 3-31: Serial Port Pinouts

NANO-ULT5 SBC

3.3.5 USB 3.2 Gen 2 (10Gb/s) Connectors

- CN Label:** USB1, USB2
- CN Type:** USB 3.2 Gen 2 port
- CN Location:** See **Figure 3-27**
- CN Pinouts:** See **Table 3-30** and **Figure 3-32**

The NANO-ULT5 has four external USB 3.2 Gen 2 (10Gb/s) ports. The USB connector can be connected to a USB 2.0 or USB 3.2 device. The pinouts of USB 3.2 Gen 2 connectors are shown below.

Pin	Description	Pin	Description
1	USB_VCC	2	USB2_D0-
3	USB2_D0-	4	GND
5	USB3_RXD0-	6	USB3_RXD0+
7	GND	8	USB3_TXD0-
9	USB3_TXD0+	10	USB_VCC
11	USB2_D1-	12	USB2_D1+
13	GND	14	USB3_RXD1-
15	USB3_RXD1+	16	GND
17	USB3_TXD1-	18	USB3_TXD1+

Table 3-30: USB 3.2 Gen 2 Port Pinouts

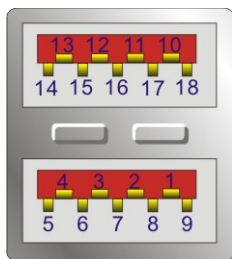

Figure 3-32: USB 3.2 Gen 2 Port Pinouts

Chapter

4

Installation

NANO-ULT5 SBC

4.1 Anti-static Precautions



WARNING:

Failure to take ESD precautions during the installation of the NANO-ULT5 may result in permanent damage to the NANO-ULT5 and severe injury to the user.

Electrostatic discharge (ESD) can cause serious damage to electronic components, including the NANO-ULT5. Dry climates are especially susceptible to ESD. It is therefore critical that whenever the NANO-ULT5 or any other electrical component is handled, the following anti-static precautions are strictly adhered to.

- ***Wear an anti-static wristband:*** Wearing a simple anti-static wristband can help to prevent ESD from damaging the board.
- ***Self-grounding*** Before handling the board, touch any grounded conducting material. During the time the board is handled, frequently touch any conducting materials that are connected to the ground.
- ***Use an anti-static pad:*** When configuring the NANO-ULT5, place it on an anti-static pad. This reduces the possibility of ESD damaging the NANO-ULT5.
- ***Only handle the edges of the PCB:*** When handling the PCB, hold the PCB by the edges.

4.2 Installation Considerations



NOTE:

The following installation notices and installation considerations should be read and understood before installation. All installation notices must be strictly adhered to. Failing to adhere to these precautions may lead to severe damage and injury to the person performing the installation.

**WARNING:**

The installation instructions described in this manual should be carefully followed in order to prevent damage to the NANO-ULT5, NANO-ULT5 components and injury to the user.

Before and during the installation please **DO** the following:

- Read the user manual:
 - The user manual provides a complete description of the NANO-ULT5 installation instructions and configuration options.
- Wear an electrostatic discharge cuff (ESD):
 - Electronic components are easily damaged by ESD. Wearing an ESD cuff removes ESD from the body and helps prevent ESD damage.
- Place the NANO-ULT5 on an antistatic pad:
 - When installing or configuring the motherboard, place it on an antistatic pad. This helps to prevent potential ESD damage.
- Turn all power to the NANO-ULT5 off:
 - When working with the NANO-ULT5, make sure that it is disconnected from all power supplies and that no electricity is being fed into the system.

Before and during the installation of the NANO-ULT5 **DO NOT**:

- Remove any of the stickers on the PCB board. These stickers are required for warranty validation.
- Use the product before verifying all the cables and power connectors are properly connected.
- Allow screws to come in contact with the PCB circuit, connector pins, or its components.

NANO-ULT5 SBC

4.3 SO-DIMM Installation

To install an SO-DIMM, please follow the steps below and refer to **Figure 4-1**.

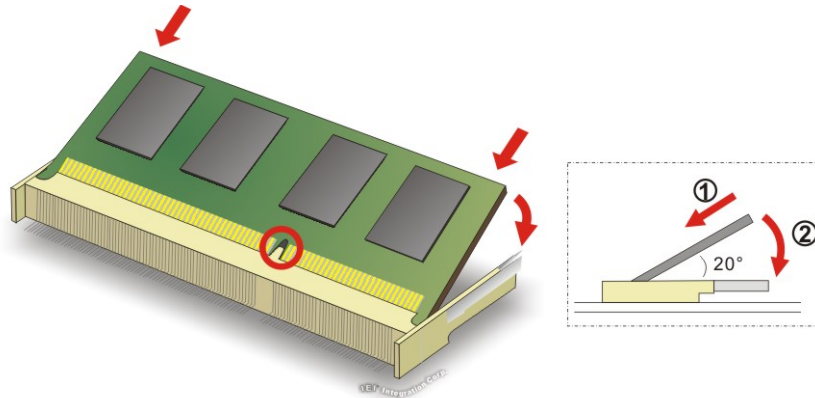

Figure 4-1: SO-DIMM Installation

- Step 1:** Locate the SO-DIMM socket. Place the board on an anti-static mat.
- Step 2:** Align the SO-DIMM with the socket. Align the notch on the memory with the notch on the memory socket.
- Step 3:** Insert the SO-DIMM. Push the memory in at a 20° angle. (See **Figure 4-1**)
- Step 4:** Seat the SO-DIMM. Gently push downwards and the arms clip into place. (See **Figure 4-1**)

**CAUTION:**

For dual channel configuration, always install two identical memory modules that feature the same capacity, timings, voltage, number of ranks and the same brand.

4.4 M.2 Module Installation

To install an M.2 module, please follow the steps below.

- Step 1:** Locate the M.2 module slot. See **Chapter 3**.
- Step 2:** Remove the retention screw secured on the motherboard.
- Step 3:** Line up the notch on the module with the notch on the slot. Slide the M.2 module into the socket at an angle of about 20° (**Figure 4-5**).

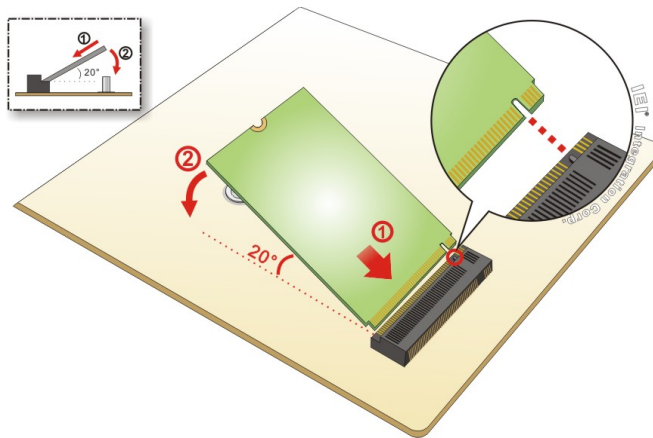

Figure 4-2: Inserting the M.2 Module into the Slot at an Angle

- Step 4:** Secure the M.2 module with the previously removed retention screw (**Figure 4-6**).

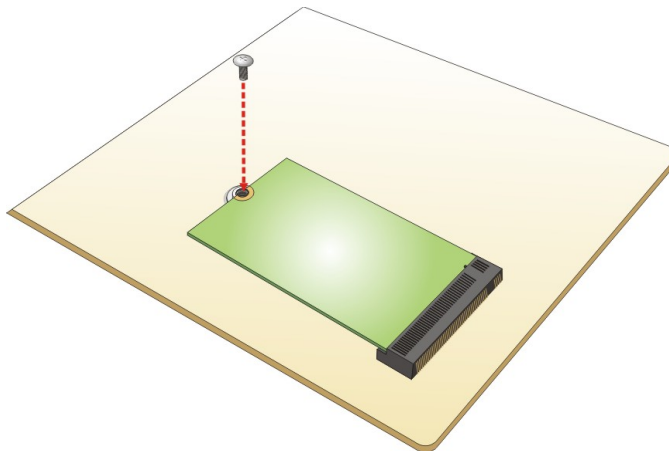

Figure 4-3: Securing the M.2 Module

NANO-ULT5 SBC

4.5 PCIe Mini Card Installation

To install a full-size PCIe Mini card, please follow the steps below.

Step 1: Locate the full-size PCIe Mini card slot. See **Chapter 3**.

Step 2: Remove the retention screw as shown in **Figure 4-4**.

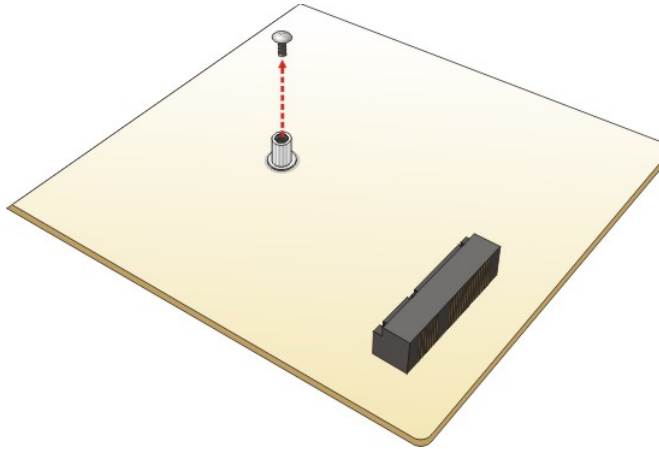

Figure 4-4: Removing the Retention Screw

Step 3: Line up the notch on the card with the notch on the slot. Slide the PCIe Mini card into the socket at an angle of about 20° (**Figure 4-5**).

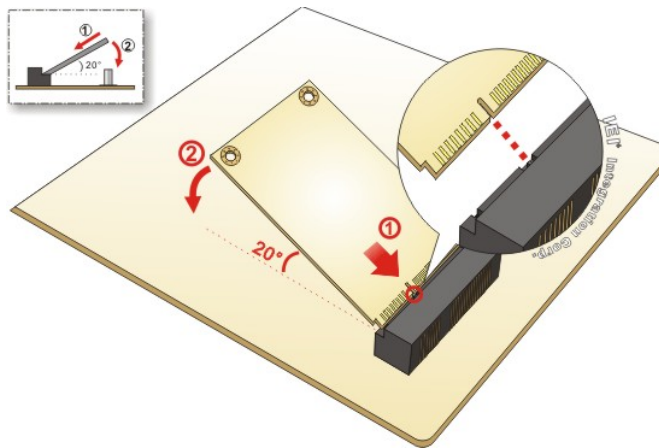

Figure 4-5: Inserting the Full-size PCIe Mini Card into the Slot at an Angle

Step 4: Secure the full-size PCIe Mini card with the retention screw previously removed (**Figure 4-6**).

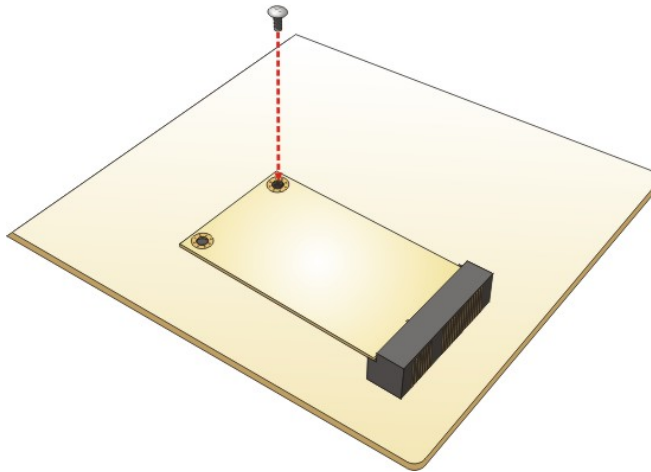

Figure 4-6: Securing the Full-size PCIe Mini Card

4.6 SIM Card Installation

To install a SIM card, please follow the steps below.

Step 1: Locate the SIM card slot. See **Section 3.2.22**.

Step 2: Unlock the SIM card slot cover by sliding the cover in the direction as shown by the arrow in **Figure 4-7**.



Figure 4-7: Unlock SIM Card Slot Cover

Step 3: Open the slot cover and place a SIM card onto the slot. The cut mark on the corner should be facing away from the slot as shown in **Figure 4-8**.

NANO-ULT5 SBC

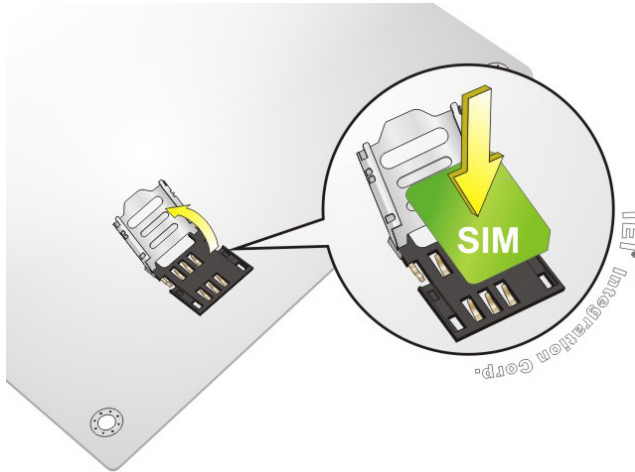

Figure 4-8: SIM Card Installation

Step 4: Close the slot cover and lock it by sliding it in the direction as shown by the arrow in **Figure 4-9**.



Figure 4-9: Lock SIM Card Slot Cover



NOTE:

A WWAN module must be installed in the PCIe Mini slot (MINI_PICE1) to provide WWAN communication.

4.7 System Configuration

The system configuration is controlled by buttons, jumpers and switches. The system configuration should be performed before installation.

4.7.1 AT/ATX Mode Select Switch

CN Label:	J_ATX_AT1
CN Type:	Switch
CN Location:	See Figure 4-10
CN Settings:	See Table 4-1

The AT/ATX mode select switch specifies the systems power mode as AT or ATX. AT/ATX mode select switch settings are shown in **Table 4-1**.

Setting	Description
Short A-B	ATX Mode (Default)
Short B-C	AT Mode

Table 4-1: AT/ATX Mode Select Switch Settings

The location of the AT/ATX mode select switch is shown in **Figure 4-10** below.

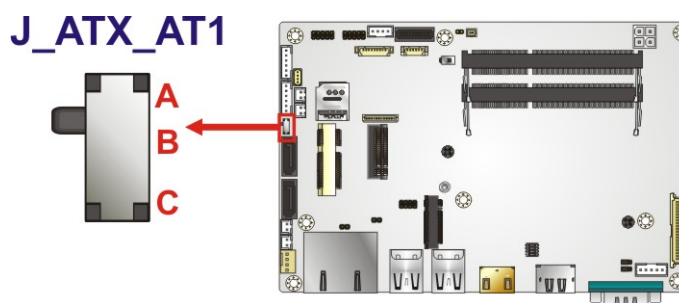

Figure 4-10: AT/ATX Mode Select Switch Location

NANO-ULT5 SBC

4.7.2 Clear CMOS Button

CN Label:	J_CMOS1
CN Type:	Button
CN Location:	See Figure 4-11

If the NANO-ULT5 fails to boot due to improper BIOS settings, use the button to clear the CMOS data and reset the system BIOS information.

The location of the clear CMOS button is shown in **Figure 4-11**

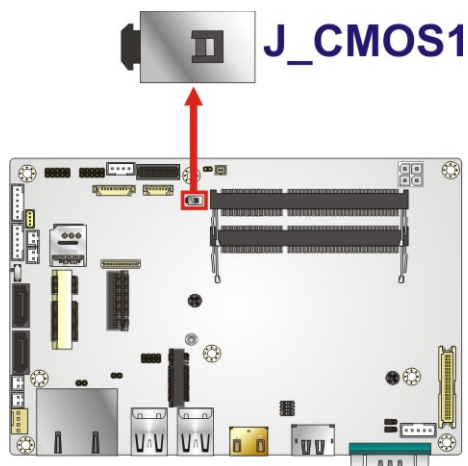

Figure 4-11: Clear CMOS Button Location

4.7.3 Backlight Mode Select Jumper

- Jumper Label:** BL_MODE1
- Jumper Type:** 3-pin header, p=1.27 mm
- Jumper Settings:** See Table 4-2
- Jumper Location:** See **Figure 4-12**

The Backlight Mode Select jumper selects the backlight mode. The Backlight Mode Select jumper settings are shown in **Table 4-2**.

Setting	Description
Short 1-2	PWM MODE (Default)
Short 2-3	DC MODE

Table 4-2: Backlight Mode Select Jumper Settings

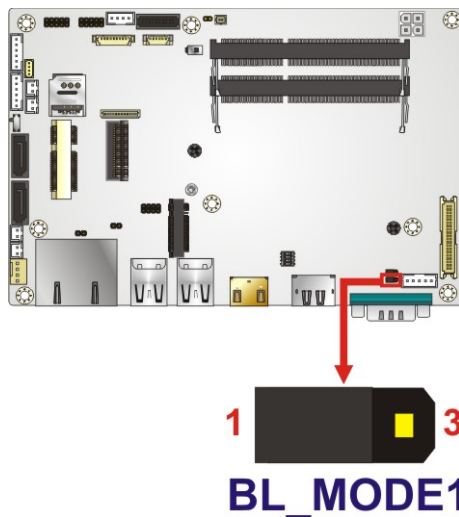

Figure 4-12: Backlight Mode Select Jumper Location

NANO-ULT5 SBC

4.7.4 Flash Descriptor Security Override Jumper

CN Label:	ME_FLASH1
CN Type:	2-pin header, p=1.27 mm
CN Location:	See Figure 4-13
CN Settings:	See Table 4-3

The Flash Descriptor Security Override jumper (ME_FLASH1) allows to enable or disable the ME firmware update. Refer to **Figure 4-13** and **Table 4-3** for the jumper location and settings.

Setting	Description
Open	Disabled (Default)
Short	Enabled

Table 4-3: Flash Descriptor Security Override Jumper Settings

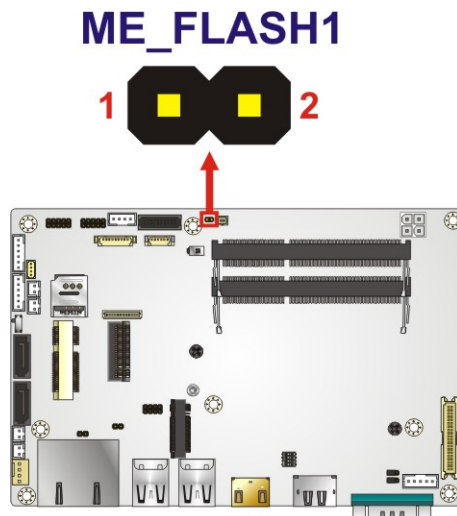

Figure 4-13: Flash Descriptor Security Override Jumper Location

To update the ME firmware, please follow the steps below.

- Step 1:** Before turning on the system power, short the Flash Descriptor Security Override jumper.

- Step 2:** Update the BIOS and ME firmware, and then turn off the system power.
- Step 3:** Remove the metal clip on the Flash Descriptor Security Override jumper to its default setting.
- Step 4:** Restart the system. The system will reboot 2 ~ 3 times to complete the ME firmware update.

4.7.5 LCD Voltage Selection



WARNING:

Incorrect voltages can destroy the LCD panel. Make sure to select a voltage that matches the voltage required by the LCD panel.

- CN Label:** JP1
- CN Type:** 3-pin header, p=1.27 mm
- CN Location:** See **Figure 4-14**
- CN Settings:** See **Table 4-4**

The LCD voltage selection jumper sets the voltage of the power supplied to the LCD panel.

Setting	Description
Short 1-2	+3.3 V (Default)
Short 2-3	+5.0 V

Table 4-4: LCD Voltage Selection Jumper Settings

NANO-ULT5 SBC

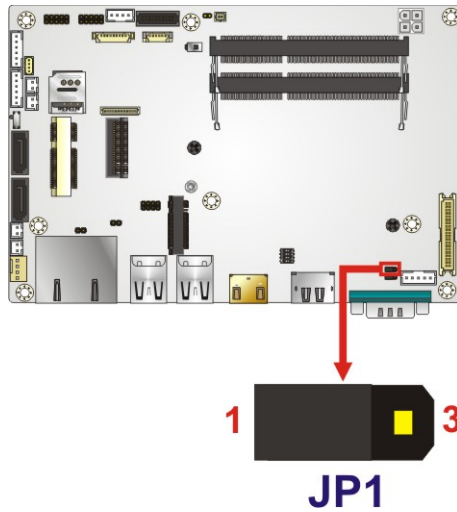

Figure 4-14: LCD Voltage Selection Jumper Location

4.7.6 LVDS Panel Resolution Select Switch

- Jumper Label:** SW1
- Jumper Type:** DIP switch
- Jumper Settings:** See Table 4-5
- Jumper Location:** See Figure 4-15

Selects the resolution of the LCD panel connected to the LVDS connector.

* ON=0, OFF=1; Single=S, Dual=D

SW1 (4-3-2-1)	Description
0000	800x600 18-bit S (default)
0001	1024x768 18-bit S
0010	1024x768 24-bit S
0011	1280x768 18-bit S
0100	1280x800 18-bit S
0101	1280x960 18-bit S
0110	1280x1024 24-bit D
0111	1366x768 18-bit S
1000	1366x768 24-bit S

SW1 (4-3-2-1)	Description
1001	1440x960 24-bit D
1010	1400x1050 24-bit D
1011	1600x900 24-bit D
1100	1680x1050 24-bit D
1101	1600x1200 24-bit D
1110	1920x1080 24-bit D
1111	1920x1200 24-bit D

Table 4-5: LVDS Panel Resolution Selection

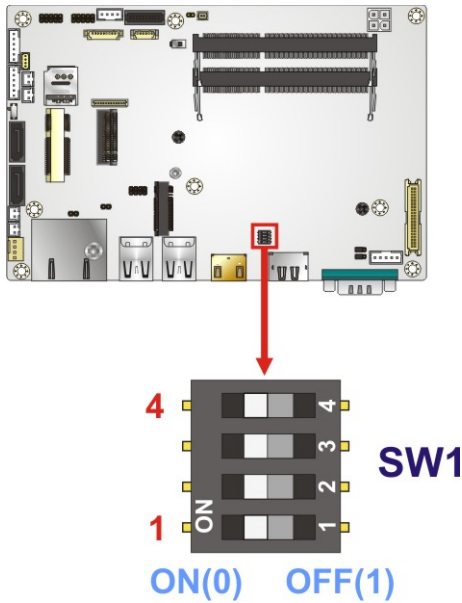

Figure 4-15: LVDS Panel Resolution Select Switch Location

NANO-ULT5 SBC

4.8 Chassis Installation

4.8.1 Heat Spreader

**WARNING:**

The heat spreader installed on the NANO-ULT5 can only serve as a heat conductor, which needs additional heat dissipation mechanism to achieve suitable thermal condition. DO NOT put the NANO-ULT5 with the heat spreader directly on a surface that cannot dissipate system heat, and never run the NANO-ULT5 without the heat spreader secured to the board.

When the NANO-ULT5 is shipped, it is secured to a heat spreader with six retention screws. The heat spreader must have a direct contact with a heat dissipation surface to ensure stable operation. In addition, a thin layer of thermal paste has to be applied onto the heat dissipation surface where it contacts the heat spreader. The following diagrams show an example of a heat sink module and how it can be installed for dissipating the heat generated from the motherboard:

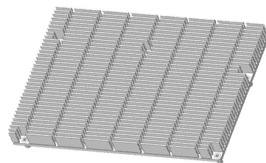
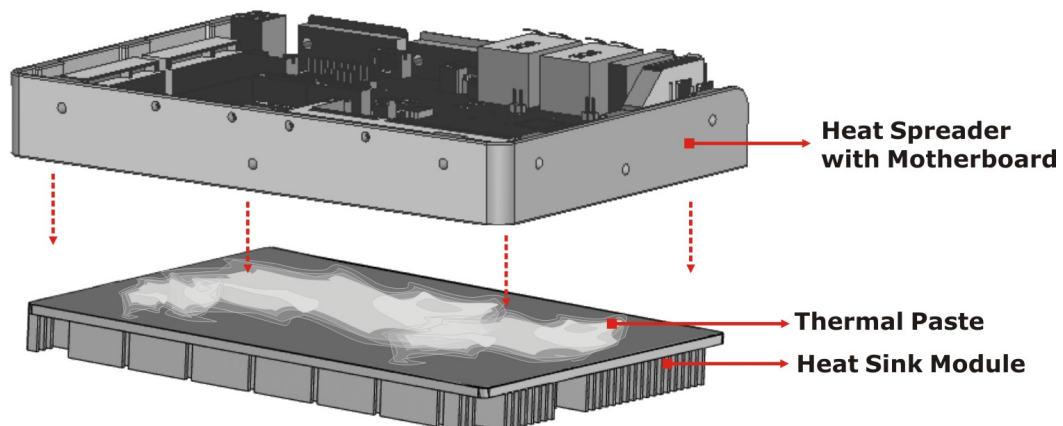
**Heat sink module:****Material:** Aluminum**Size:** 160 mm x 200 mm x 34 mm

If the NANO-ULT5 must be removed from the heat spreader, the six retention screws must be removed.

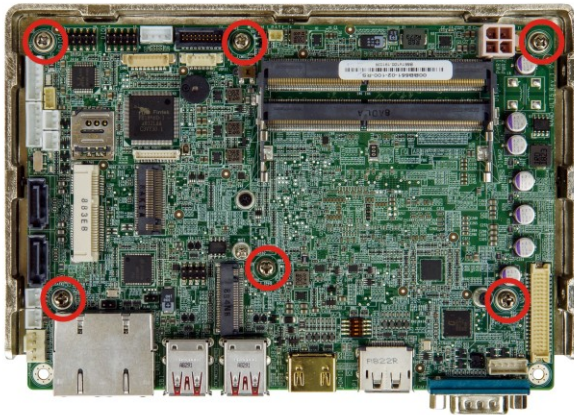

Figure 4-16: Heat Sink Retention Screws

4.8.2 Motherboard Installation Example

Each side of the heat spreader has several screw holes allowing the NANO-ULT5 to be mounted into a chassis or a heat sink enclosure (please refer to Figure 1-3 for the detailed dimensions). The user has to design or select a chassis or a heat sink enclosure that has screw holes matching up with the holes on the heat spreader for installing the NANO-ULT5. The following diagram shows an example of motherboard installation.

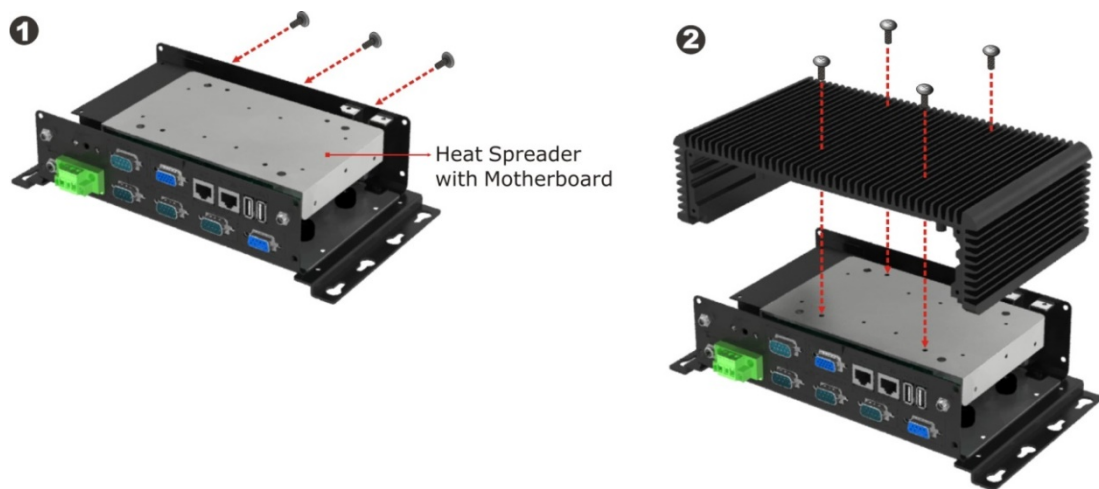

Figure 4-17: Motherboard Installation Example

NANO-ULT5 SBC

4.9 Internal Peripheral Device Connections

This section outlines the installation of peripheral devices to the on-board connectors

4.9.1 AT Power Connection

Follow the instructions below to connect the NANO-ULT5 to an AT power supply.



WARNING:

Disconnect the power supply power cord from its AC power source to prevent a sudden power surge to the NANO-ULT5.

Step 1: **Locate the power cable.** The power cable is shown in the packing list in **Chapter 2.**

Step 2: **Connect the power cable to the motherboard.** Connect the 4-pin (2x2) Molex type power cable connector to the power connector on the motherboard. See Figure 4-18.

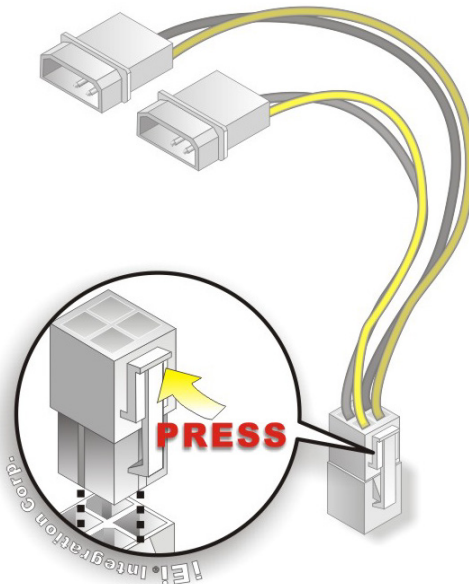

Figure 4-18: Power Cable to Motherboard Connection

Step 3: Connect power cable to power supply. Connect one of the 4-pin (1x4) Molex type power cable connectors to an AT power supply. See Figure 4-19.

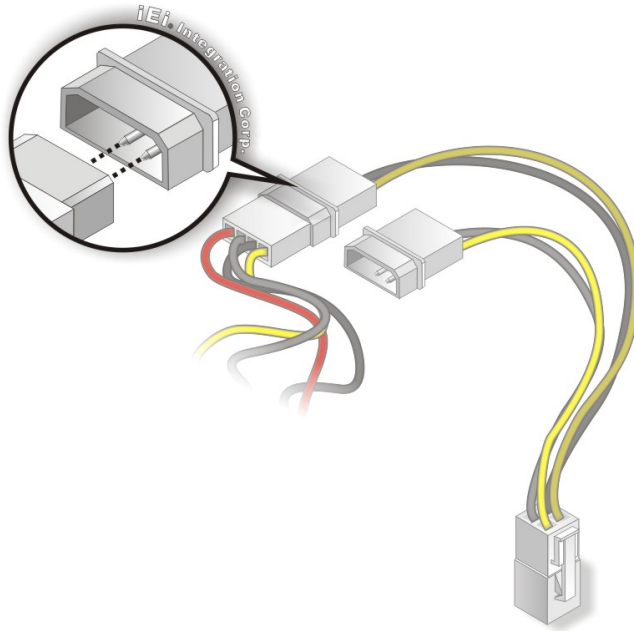

Figure 4-19: Connect Power Cable to Power Supply

4.9.2 Audio Kit Installation

The Audio Kit that came with the NANO-ULT5 connects to the audio connector on the NANO-ULT5. The audio kit consists of three audio jacks. Mic-in connects to a microphone. Line-in provides a stereo line-level input to connect to the output of an audio device. Line-out, a stereo line-level output, connects to two amplified speakers. To install the audio kit, please refer to the steps below:

Step 1: **Locate the audio connector.** The location of the 10-pin audio connector is shown in **Chapter 3**.

Step 2: **Align pin 1.** Align pin 1 on the on-board connector with pin 1 on the audio kit connector. Pin 1 on the audio kit connector is indicated with a white dot. See **Figure 4-20**.

NANO-ULT5 SBC

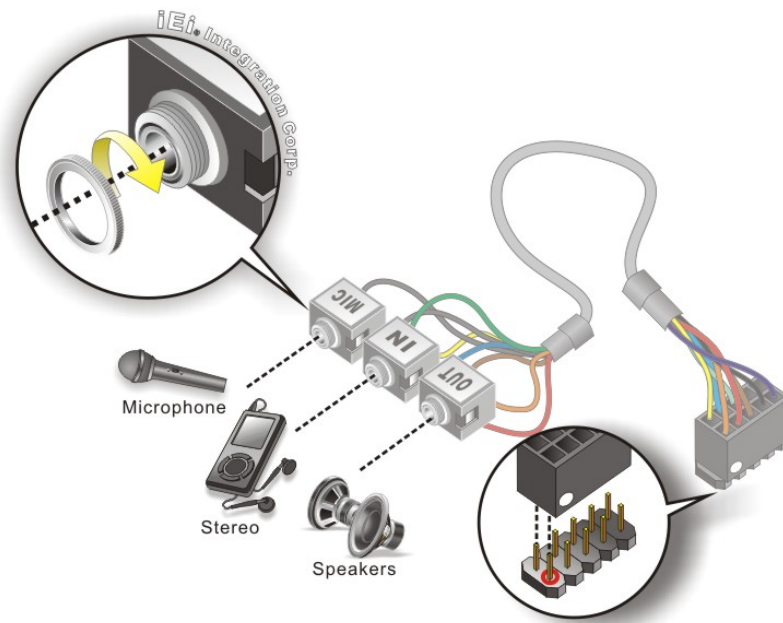

Figure 4-20: Audio Kit Cable Connection

Step 3: Connect the audio devices. Connect speakers to the line-out audio jack. Connect the output of an audio device to the line-in audio jack. Connect a microphone to the mic-in audio jack.

4.9.3 RS-232 Cable Connection

The single RS-232 cable consists of one serial port connector attached to a serial communications cable that is then attached to a D-sub 9 male connector. To install the single RS-232 cable, please follow the steps below.

Step 1: Locate the connector. The location of the RS-232 connector is shown in **Chapter 3**.

Step 2: Insert the cable connector. Align the cable connector with the onboard connector. Make sure pin 1 on the board and connector line up. Pin 1 on the cable connector is indicated with a white dot. See **Figure 4-21**.

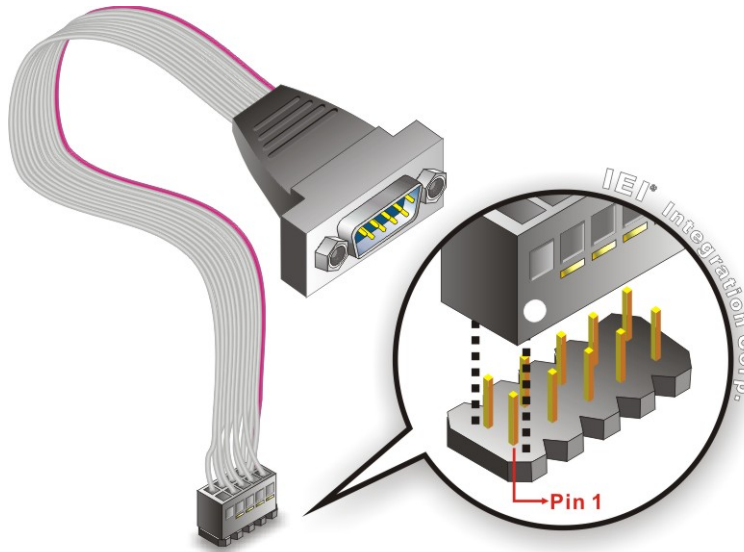

Figure 4-21: Single RS-232 Cable Installation

- Step 3: Secure the bracket.** The single RS-232 connector has two retention screws that must be secured to a chassis or bracket.
- Step 4: Connect the serial device.** Once the single RS-232 connector is connected to a chassis or bracket, a serial communications device can be connected to the system.

4.9.4 SATA Drive Connection

The NANO-ULT5 is shipped with a SATA drive cable. To connect the SATA drive to the connector, please follow the steps below.

- Step 1: Locate the SATA connector and the SATA power connector.** The locations of the connectors are shown in **Chapter 3**.
- Step 2: Insert the cable connector.** Insert the cable connector into the on-board SATA drive connector and the SATA power connector. See **Figure 4-22**.

NANO-ULT5 SBC

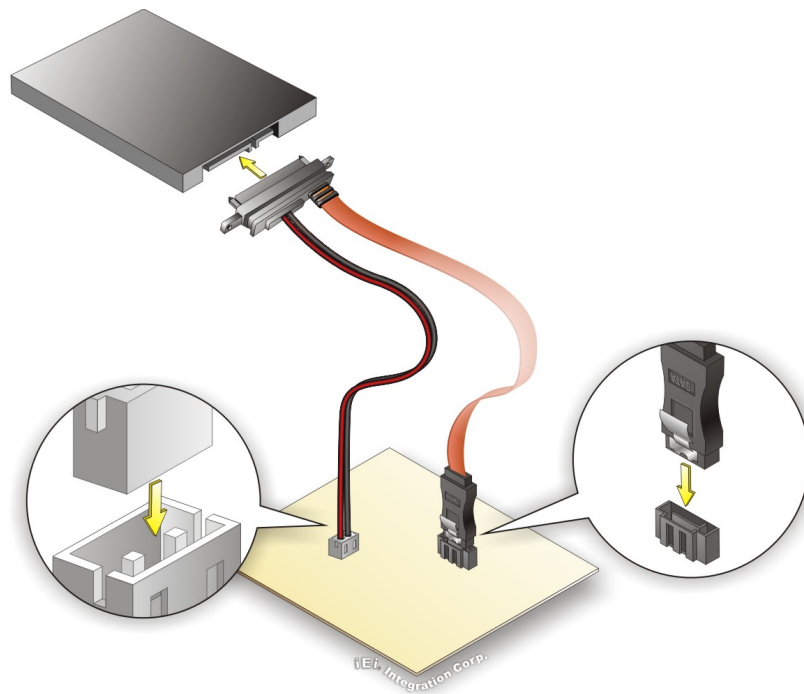

Figure 4-22: SATA Drive Cable Connection

- Step 3:** **Connect the cable to the SATA disk.** Connect the connector on the other end of the cable to the connector at the back of the SATA drive. See **Figure 4-22**.
- Step 4:** To remove the SATA cable from the SATA connector, press the clip on the connector at the end of the cable.

4.10 Intel® AMT Setup Procedure

The NANO-ULT5 is featured with the Intel® Active Management Technology (AMT). To enable the Intel® AMT function, follow the steps below.

- Step 1:** Make sure at least one of the memory sockets is installed with a DDR4 SO-DIMM.
- Step 2:** Connect an Ethernet cable to the RJ-45 connector labeled **LAN1**.
- Step 3:** The AMI BIOS options regarding the Intel® ME or Intel® AMT must be enabled,
- Step 4:** Properly install the Intel® Management Engine Components drivers from the Intel AMT (ME) directory in the driver CD.
- Step 5:** Configure the Intel® Management Engine BIOS extension (MEBx). To get into the Intel® MEBx settings, press <Ctrl+P> after a single beep during boot-up process. Enter the Intel® current ME password as it requires (the Intel® default password is **admin**).



NOTE:

To change the password, enter a new password following the strong password rule (containing at least one upper case letter, one lower case letter, one digit and one special character, and be at least eight characters).

Chapter

5

BIOS

5.1 Introduction

The BIOS is programmed onto the BIOS chip. The BIOS setup program allows changes to certain system settings. This chapter outlines the options that can be changed.



NOTE:

Some of the BIOS options may vary throughout the life cycle of the product and are subject to change without prior notice.

5.1.1 Starting Setup

The UEFI BIOS is activated when the computer is turned on. The setup program can be activated in one of two ways.

1. Press the **DELETE** or **F2** key as soon as the system is turned on or
2. Press the **DELETE** or **F2** key when the “**Press Del to enter SETUP**” message appears on the screen.

If the message disappears before the **DELETE** or **F2** key is pressed, restart the computer and try again.

5.1.2 Using Setup

Use the arrow keys to highlight items, press **ENTER** to select, use the PageUp and PageDown keys to change entries, press **F1** for help and press **ESC** to quit. Navigation keys are shown in.

Key	Function
Up arrow	Move to previous item
Down arrow	Move to next item
Left arrow	Move to the item on the left hand side
Right arrow	Move to the item on the right hand side
+	Increase the numeric value or make changes

NANO-ULT5 SBC

Key	Function
-	Decrease the numeric value or make changes
F1 key	General help, only for Status Page Setup Menu and Option Page Setup Menu
F2 key	Load previous values.
F3 key	Load optimized defaults
F4 key	Save changes and Exit BIOS
Esc key	Main Menu – Quit and not save changes into CMOS Status Page Setup Menu and Option Page Setup Menu -- Exit current page and return to Main Menu

5.1.3 Getting Help

When **F1** is pressed a small help window describing the appropriate keys to use and the possible selections for the highlighted item appears. To exit the Help Window press **Esc** or the **F1** key again.

5.1.4 Unable to Reboot after Configuration Changes

If the computer cannot boot after changes to the system configuration is made, CMOS defaults. Use the jumper described in **Section 4.7.2**.

5.1.5 BIOS Menu Bar

The **menu bar** on top of the BIOS screen has the following main items:

- Main – Changes the basic system configuration.
- Advanced – Changes the advanced system settings.
- Chipset – Changes the chipset settings.
- Security – Sets User and Supervisor Passwords.
- Boot – Changes the system boot configuration.
- Save & Exit – Selects exit options and loads default settings

The following sections completely describe the configuration options found in the menu items at the top of the BIOS screen and listed above.

5.2 Main

The **Main** BIOS menu (**BIOS Menu 1**) appears when the **BIOS Setup** program is entered.

```

Aptio Setup Utility - Copyright (C) 2019 American Megatrends, Inc.
Main  Advanced  Chipset  Security  Boot  Save & Exit
BIOS Information
BIOS Vendor                American Megatrends
Core Version                5.13
Compliance                 UEFI 2.7; PI 1.6
Project Version            B551AR11.ROM
Build Date and Time        05/14/2019 16:11:34

iWDD Vendor                iEi
iWDD Version                B551ET05.bin

Processor Information
Name                       WhiskeyLake ULT
Type                       Intel(R) Core(TM)
                           i3-8145EU CPU@ 2.20GHz
Speed                      2400 MHz
ID                          406E3
Stepping                   V0
Number of Processors       2Core(s) / 4Thread(s)
Microcode Revision         B8
GT Info                     GT2 (0x3EA0)

IGFX VBIOS Version         1017
Memory RC Version          0.7.1.95
Total Memory                4096 MB
Memory Frequency           2133 MHz

PCH Information
Name                       CNL PCH-LP
PCH SKU                     (U) Premium SKU
Stepping                    D0

ME FW Version              12.0.35.1427
ME Firmware SKU            Corporate SKU

Access Level                Administrator

System Date                 [Fri 01/01/2010]
System Time                 [00:18:35]

-----
<=>: Select Screen
↑↓: Select Item
Enter: Select
+/-: Change Opt.
F1  General Help
F2  Previous Values
F3  Optimized Defaults
F4  Save
ESC Exit

Version 2.20.1271. Copyright (C) 2019 American Megatrends, Inc.

```

BIOS Menu 1: Main

The System Overview field also has two user configurable fields:

NANO-ULT5 SBC

→ System Date [xx/xx/xx]

Use the **System Date** option to set the system date. Manually enter the day, month and year.

→ System Time [xx:xx:xx]

Use the **System Time** option to set the system time. Manually enter the hours, minutes and seconds.

5.3 Advanced

Use the **Advanced** menu (**BIOS Menu 2**) to configure the CPU and peripheral devices through the following sub-menus:



WARNING!

Setting the wrong values in the sections below may cause the system to malfunction. Make sure that the settings made are compatible with the hardware.

```

Aptio Setup Utility - Copyright (C) 2019 American Megatrends, Inc.
Main  Advanced  Chipset  Security  Boot  Save & Exit
-----
> CPU Configuration
> PCH-FW Configuration
> Trusted Computing
> ACPI Settings
> RTC Wake Settings
> iWDD H/W Monitor
> F81866 Super IO Configuration
> Serial Port Console Redirection
> USB Configuration
> CSM Configuration
> NVMe Configuration
> iEi Feature

System ACPI Parameters.
-----
<=>: Select Screen
↑ ↓: Select Item
EnterSelect
F1  General Help
F2  Previous Values
F3  Optimized Defaults
F4  Save
ESC Exit

Version 2.20.1271. Copyright (C) 2019 American Megatrends, Inc.
    
```

BIOS Menu 2: Advanced

5.3.1 CPU Configuration

Use the **CPU Configuration** menu (**BIOS Menu 3**) to view detailed CPU specifications and configure the CPU.

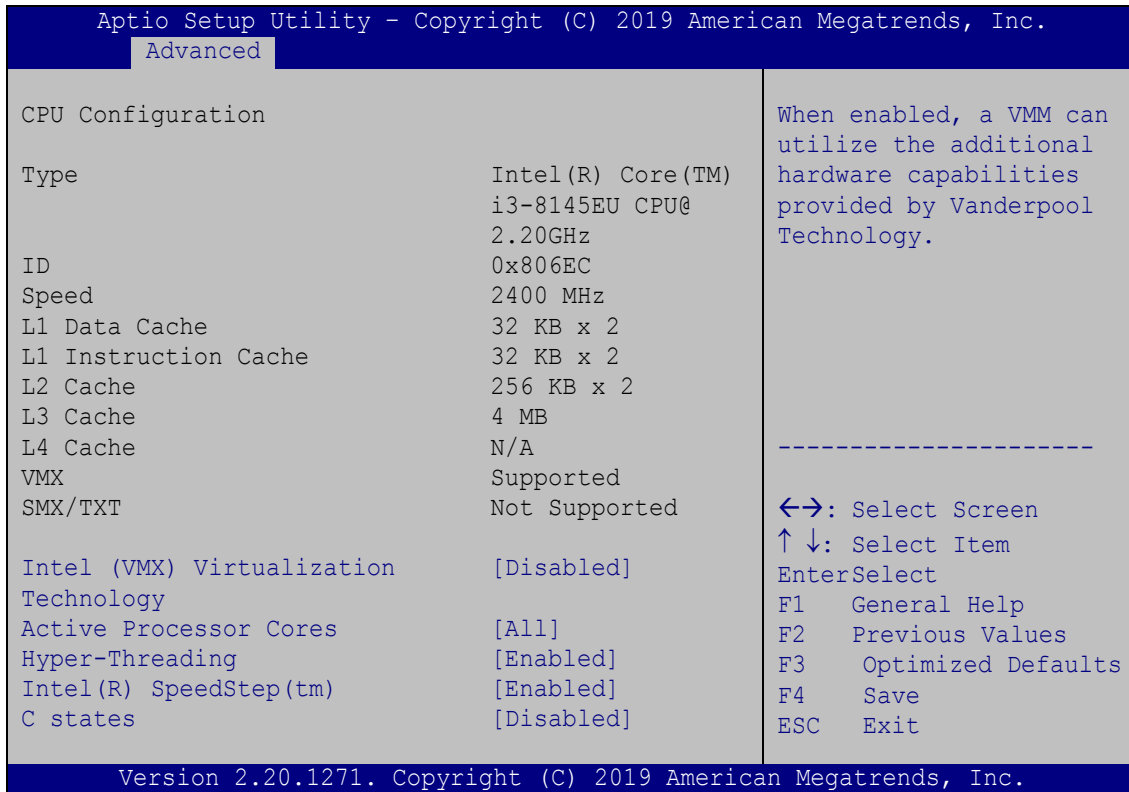

BIOS Menu 3: CPU Configuration

→ Intel® (VMX) Virtualization Technology [Disabled]

Use the **Intel® (VMX) Virtualization Technology** option to enable or disable virtualization on the system. When combined with third party software, Intel® Virtualization technology allows several OSs to run on the same system at the same time.

- **Disabled** **DEFAULT** Disables Intel® Virtualization Technology.
- **Enabled** Enables Intel® Virtualization Technology.

→ Active Processor Cores [All]

Use the **Active Processor Cores** BIOS option to enable numbers of cores in the processor package.

NANO-ULT5 SBC

- **All** **DEFAULT** Enable all cores in the processor package.
- **1** Enable one core in the processor package.

→ **Hyper-threading [Enabled]**

Use the **Hyper-threading** BIOS option to enable or disable the Intel Hyper-Threading Technology.

- **Disabled** Disables the Intel Hyper-Threading Technology.
- **Enabled** **DEFAULT** Enables the Intel Hyper-Threading Technology.

→ **Intel® SpeedStep™ [Enabled]**

Use the **Intel® SpeedStep™** option to enable or disable the Intel® SpeedStep Technology.

- **Disabled** Disables the Intel® SpeedStep Technology.
- **Enabled** **DEFAULT** Enables the Intel® SpeedStep Technology.

→ **C State [Disabled]**

Use the **C State** option to enable or disable CPU C state.

- **Disabled** **DEFAULT** Disables CPU C state.
- **Enabled** Enables CPU C state.

5.3.2 PCH-FW Configuration

The **PCH-FW Configuration** menu (**BIOS Menu 4**) allows Intel® Active Management Technology (AMT) options to be configured.

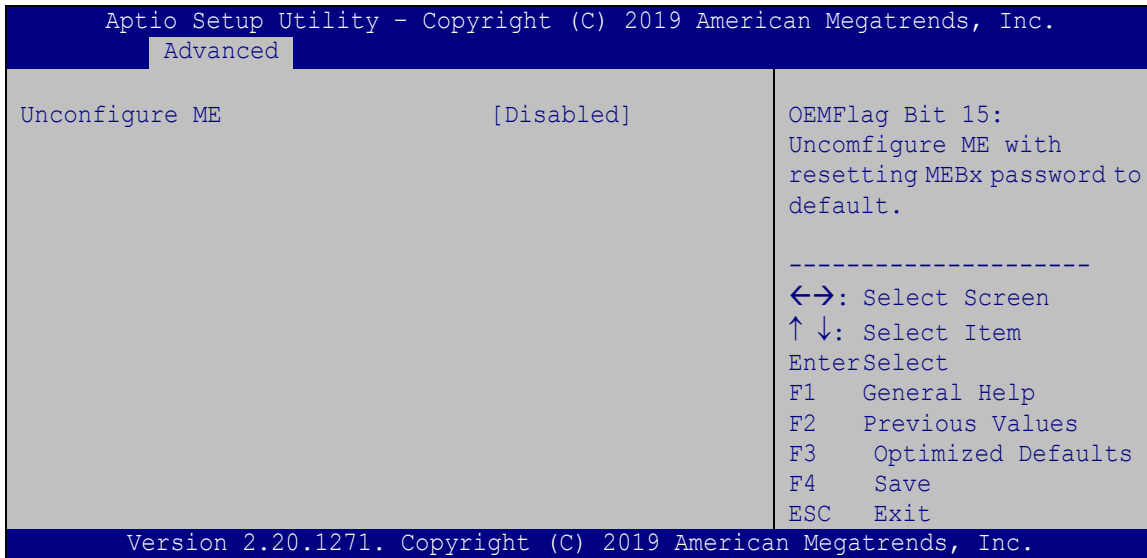

BIOS Menu 4: PCH-FW Configuration

→ Unconfigure ME [Disabled]

Use the **Unconfigure ME** option to perform ME unconfigure without password operation.

- **Disabled** **DEFAULT** Not perform ME unconfigure
- **Enabled** To perform ME unconfigure

NANO-ULT5 SBC

5.3.3 Trusted Computing

Use the **Trusted Computing** menu (**BIOS Menu 5**) to configure settings related to the Trusted Computing Group (TCG) Trusted Platform Module (TPM).

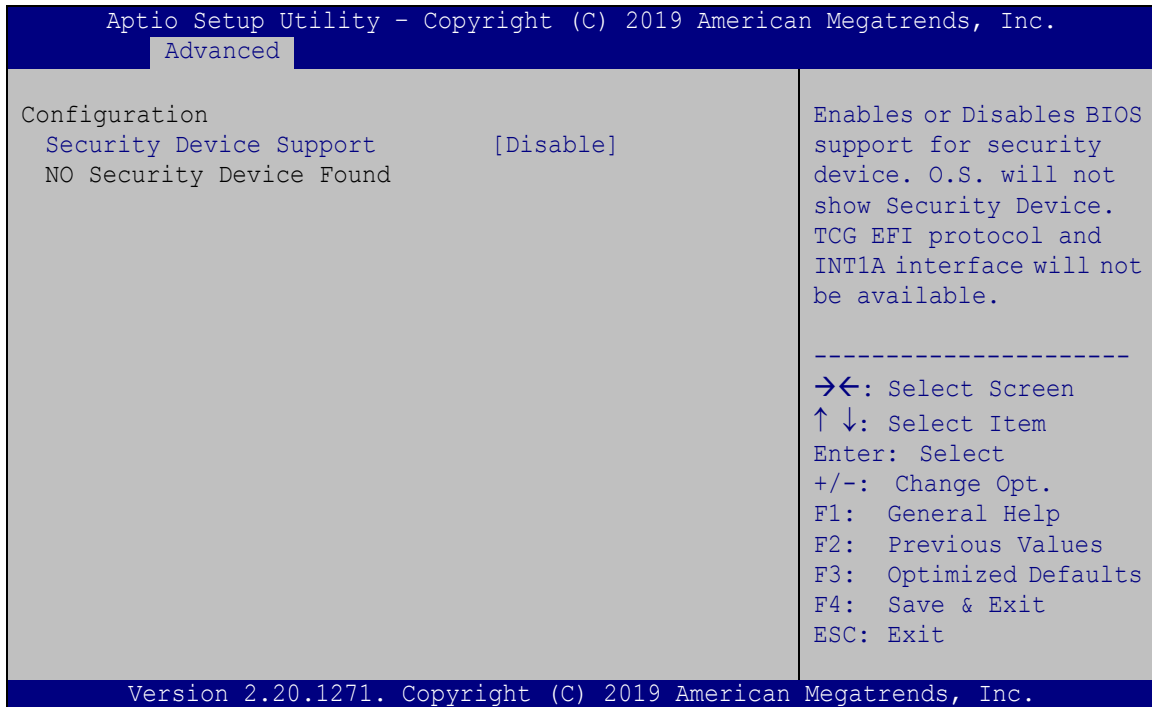

BIOS Menu 5: Trusted Computing

→ Security Device Support [Disable]

Use the **Security Device Support** option to configure support for the TPM.

- **Disable** **DEFAULT** TPM support is disabled.
- **Enable** TPM support is enabled.

5.3.4 ACPI Settings

The **ACPI Settings** menu (**BIOS Menu 6**) configures the Advanced Configuration and Power Interface (ACPI) options.

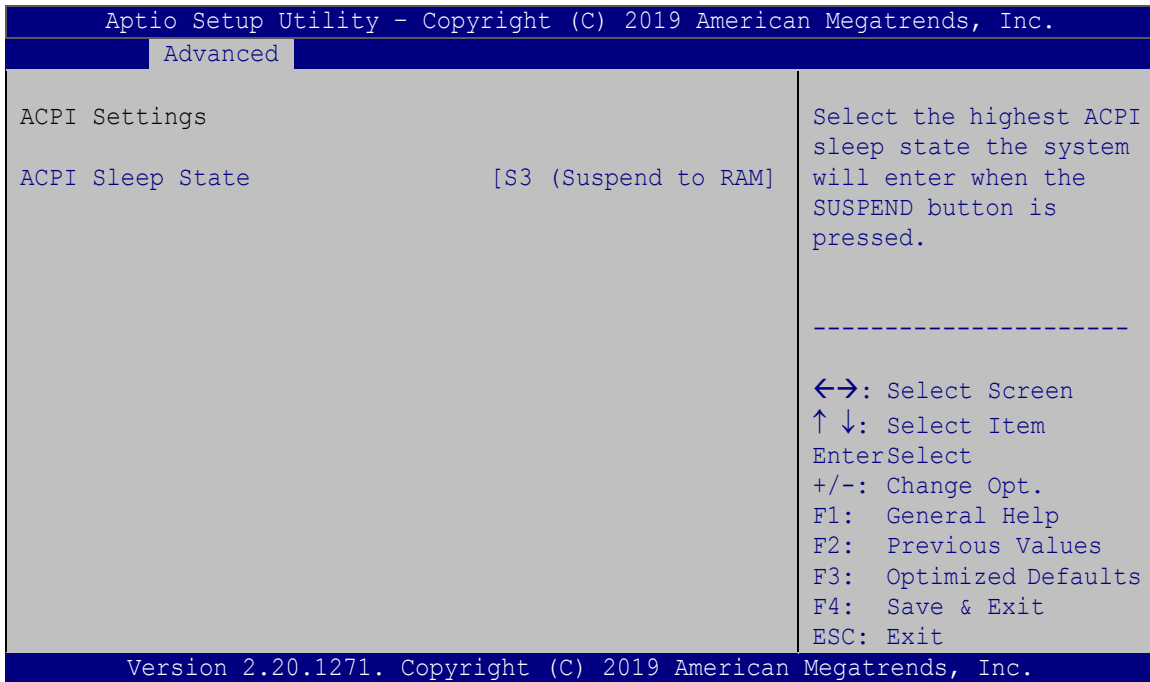

BIOS Menu 6: ACPI Settings

→ ACPI Sleep State [S3 (Suspend to RAM)]

Use the **ACPI Sleep State** option to specify the sleep state the system enters when it is not being used.

- **S3 (Suspend to DEFAULT RAM)** The caches are flushed and the CPU is powered off. Power to the RAM is maintained. The computer returns slower to a working state, but more power is saved.

NANO-ULT5 SBC

5.3.5 RTC Wake Settings

The **RTC Wake Settings** menu (**BIOS Menu 7**) configures RTC wake event.

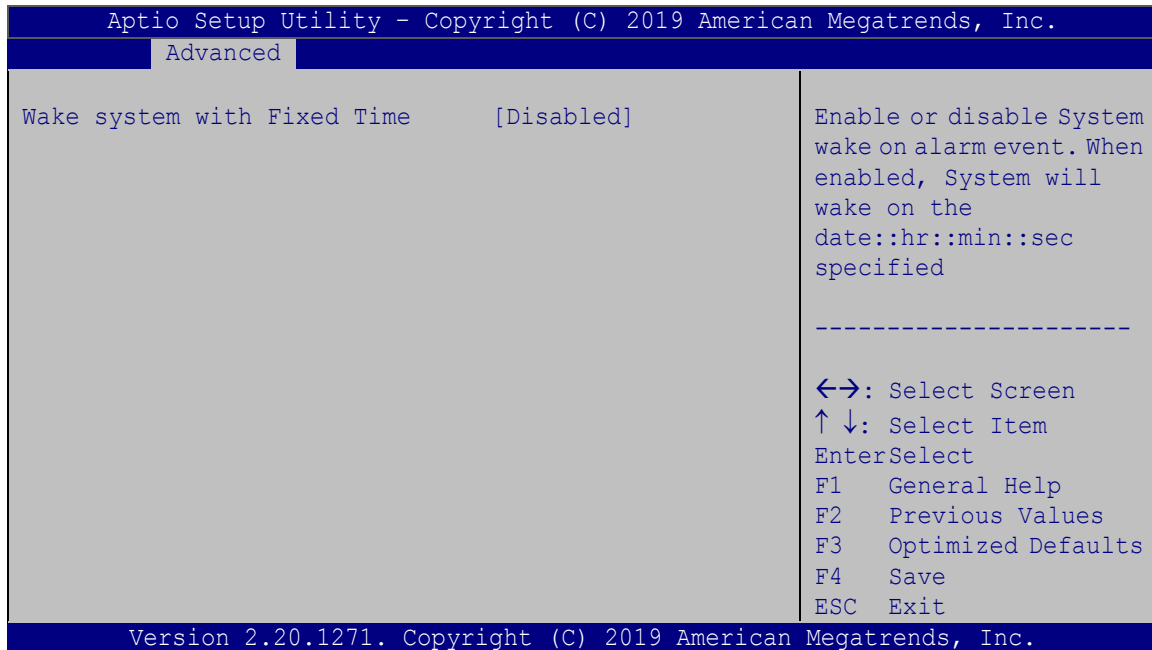

BIOS Menu 7: RTC Wake Settings

→ Wake system with Fixed Time [Disabled]

Use the **Wake system with Fixed Time** option to enable or disable the system wake on alarm event.

- **Disabled** **DEFAULT** The real time clock (RTC) cannot generate a wake event
- **Enabled** If selected, the **Wake up every day** option appears allowing you to enable to disable the system to wake every day at the specified time. Besides, the following options appear with values that can be selected:
 - Wake up date
 - Wake up hour
 - Wake up minute

Wake up second

After setting the alarm, the computer turns itself on from a suspend state when the alarm goes off.

5.3.6 iWDD H/W Monitor

The **iWDD H/W Monitor** menu (**BIOS Menu 8**) contains the fan configuration submenus and displays operating temperature, fan speeds and system voltages.

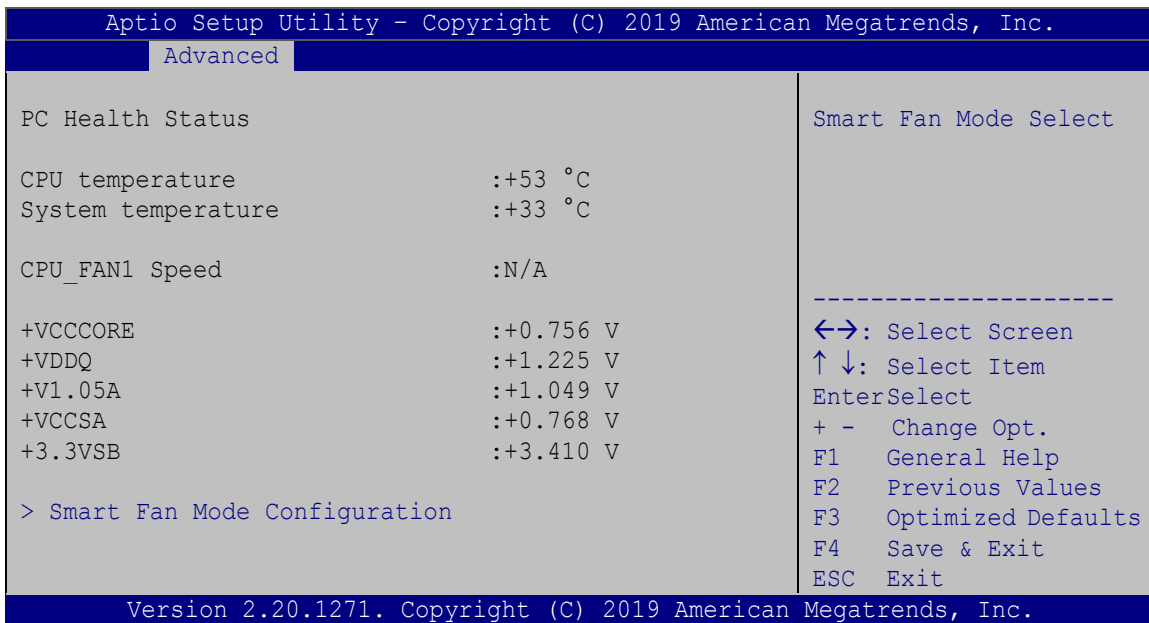

BIOS Menu 8: iWDD H/W Monitor

→ PC Health Status

The following system parameters and values are shown. The system parameters that are monitored are:

- System Temperatures:
 - CPU Temperature
 - System temperature
- Fan Speed:
 - CPU Fan Speed
- Voltages
 - +VCCCORE

NANO-ULT5 SBC

- +VDDQ
- +V1.05A
- +VCCSA
- +3.3VSB

5.3.6.1 Smart Fan Mode Configuration

Use the **Smart Fan Mode Configuration** submenu (**BIOS Menu 9**) to configure fan temperature and speed settings.

```

Aptio Setup Utility - Copyright (C) 2019 American Megatrends, Inc.
Advanced
Smart Fan Mode Configuration
CPU_FAN1 Smart Fan Control          [Auto Mode]
Auto mode fan start temperature     40
Auto mode fan off temperature       30
Auto mode fan start PWM              30
Auto mode fan slope PWM             2

Smart Fan Mode Select
-----
<=>: Select Screen
↑ ↓: Select Item
EnterSelect
+ - Change Opt.
F1  General Help
F2  Previous Values
F3  Optimized Defaults
F4  Save & Exit
ESC Exit

Version 2.20.1271. Copyright (C) 2019 American Megatrends, Inc.
    
```

BIOS Menu 9: Smart Fan Mode Configuration

→ CPU_FAN1 Smart Fan Control [Auto Mode]

Use the **CPU_FAN1 Smart Fan Control** BIOS option to configure the CPU Smart Fan.

- **Manual Mode** The fan spins at the speed set in the Manual Mode option
- **Auto Mode** **DEFAULT** The fan adjusts its speed using these settings:
 - Auto mode fan start temperature
 - Auto mode fan off temperature
 - Auto mode fan start PWM
 - Auto mode fan slope PWM

→ **Auto mode fan start temperature [40]**



WARNING:

Setting this value too high may cause the fan to rotate at full speed only when the CPU is at a very high temperature and therefore cause the system to be damaged.

The **Auto mode fan start temperature** option can only be set if the **CPU_FAN1 Smart Fan Control** option is set to **Auto Mode**. If the system temperature is between **Start Temperature** and **Off Temperature**, the fan speed change to be **Start PWM**. To set a value, select the **Auto mode fan start temperature** option and enter a decimal number between 1 and 100.

→ **Auto mode fan off temperature [30]**



WARNING:

Setting this value too high may cause the fan to speed up only when the CPU is at a very high temperature and therefore cause the system to be damaged.

The **Auto mode fan off temperature** option can only be set if the **CPU_FAN1 Smart Fan control** option is set to **Auto Mode**. If the system temperature is lower than **Auto mode fan off temperature**, the fan speed change to be lowest. To set a value, select the **Auto mode fan off temperature** option and enter a decimal number between 1 and 100.

→ **Auto mode fan start PWM [30]**

The **Auto mode fan start PWM** option can only be set if the **CPU_FAN1 Smart Fan control** option is set to **Auto Mode**. Use the **Auto mode fan start PWM** option to set the PWM start value. To set a value, select the **Auto mode fan start PWM** option and enter a decimal number between 1 and 100.

NANO-ULT5 SBC

→ Auto mode fan slope PWM [2]

The **Auto mode fan slope PWM** option can only be set if the **CPU_FAN1 Smart Fan control** option is set to **Auto Mode**. Use the **Auto mode fan slope PWM** option to select the linear rate at which the PWM mode increases with respect to an increase in temperature. To set a value, select the **Auto mode fan slope PWM** option and enter a decimal number between 1 and 8.

5.3.7 F81866 Super IO Configuration

Use the **F81866 Super IO Configuration** menu (**BIOS Menu 10**) to set or change the configurations for the serial ports.

```

Aptio Setup Utility - Copyright (C) 2019 American Megatrends, Inc.
  Advanced
F81866 Super IO Configuration
Super IO Chip                F81866
> Serial Port 1 Configuration
> Serial Port 2 Configuration
> Serial Port 3 Configuration

Set Parameters of Serial
Port 1 (COMA)
-----
←→: Select Screen
↑ ↓: Select Item
Enter>Select
F1   General Help
F2   Previous Values
F3   Optimized
Defaults
F4   Save
ESC  Exit

Version 2.20.1271. Copyright (C) 2019 American Megatrends, Inc.

```

BIOS Menu 10: F81866 Super IO Configuration

5.3.7.1 Serial Port n Configuration

Use the **Serial Port n Configuration** menu (**BIOS Menu 11**) to configure the serial port n.

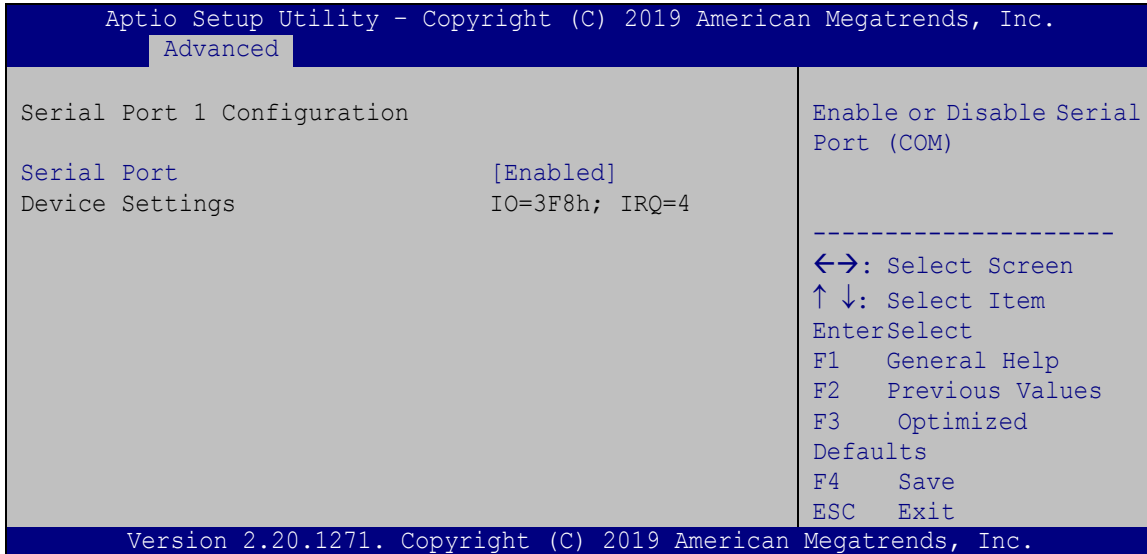

BIOS Menu 11: Serial Port n Configuration

→ Serial Port [Enabled]

Use the **Serial Port** option to enable or disable the serial port.

- **Disabled** Disable the serial port
- **Enabled** **DEFAULT** Enable the serial port

NANO-ULT5 SBC

5.3.8 Serial Port Console Redirection

The **Serial Port Console Redirection** menu (**BIOS Menu 12**) allows the console redirection options to be configured. Console redirection allows users to maintain a system remotely by re-directing keyboard input and text output through the serial port.

```

Aptio Setup Utility - Copyright (C) 2019 American Megatrends, Inc.
  Advanced
COM1
  Console Redirection [Disabled]
  > Console Redirection Settings
COM2
  Console Redirection [Disabled]
  > Console Redirection Settings
COM3
  Console Redirection [Disabled]
  > Console Redirection Settings
iAMT SOL
COM4(Pci Bus0, Dev0, Func0) (Disabled)
  Console Redirection Port Is Disabled
Legacy Console Redirection
  > Legacy Console Redirection Settings
-----
<=>: Select Screen
↑ ↓: Select Item
Enter>Select
F1  General Help
F2  Previous Values
F3  Optimized
Defaults
F4  Save
ESC Exit
Version 2.20.1271. Copyright (C) 2019 American Megatrends, Inc.
  
```

BIOS Menu 12: Serial Port Console Redirection

➔ Console Redirection [Disabled]

Use **Console Redirection** option to enable or disable the console redirection function.

- ➔ **Disabled** **DEFAULT** Disabled the console redirection function
- ➔ **Enabled** Enabled the console redirection function

5.3.8.1 Legacy Console Redirection Settings

The **Legacy Console Redirection Settings** menu (**BIOS Menu 13**) allows the legacy console redirection options to be configured.

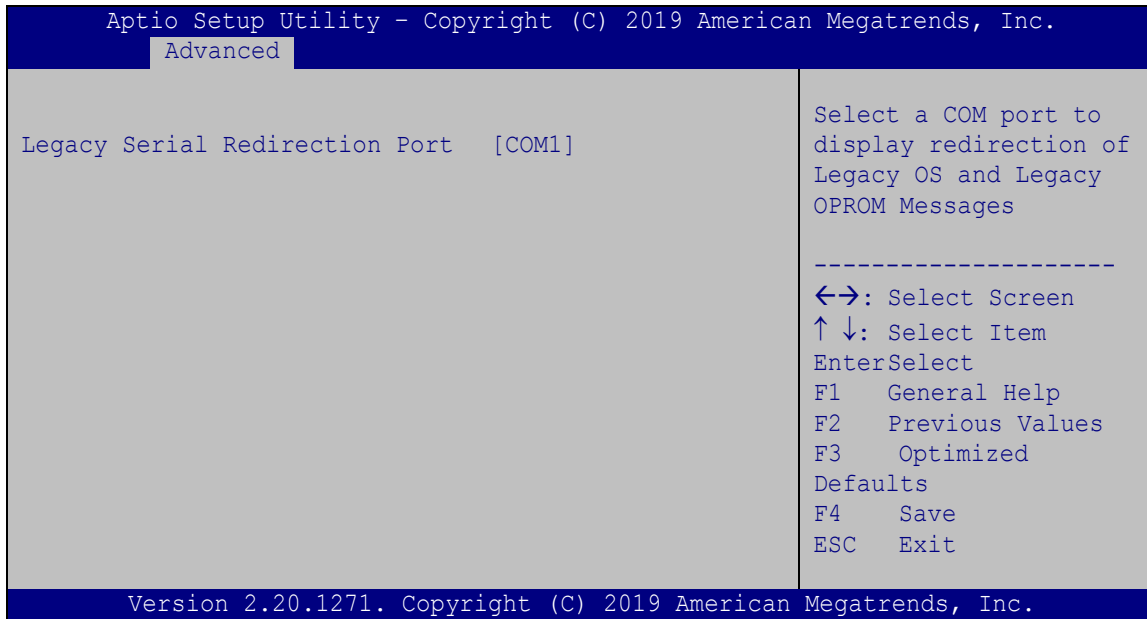

BIOS Menu 13: Legacy Console Redirection Settings

→ Legacy Serial Redirection Port [COM1]

Use the **Legacy Serial Redirection Port** option to specify a COM port to display redirection of legacy OS and legacy OPROM messages. The options include:

- COM1 **DEFAULT**
- COM2
- COM3
- COM4 (Pci Bus0, Dev0, Func0) (Disabled)

NANO-ULT5 SBC

5.3.8.2 Console Redirection Settings

The **Console Redirection Settings** menu (**BIOS Menu 14**) allows the console redirection options to be configured. The option is active when Console Redirection option is enabled.

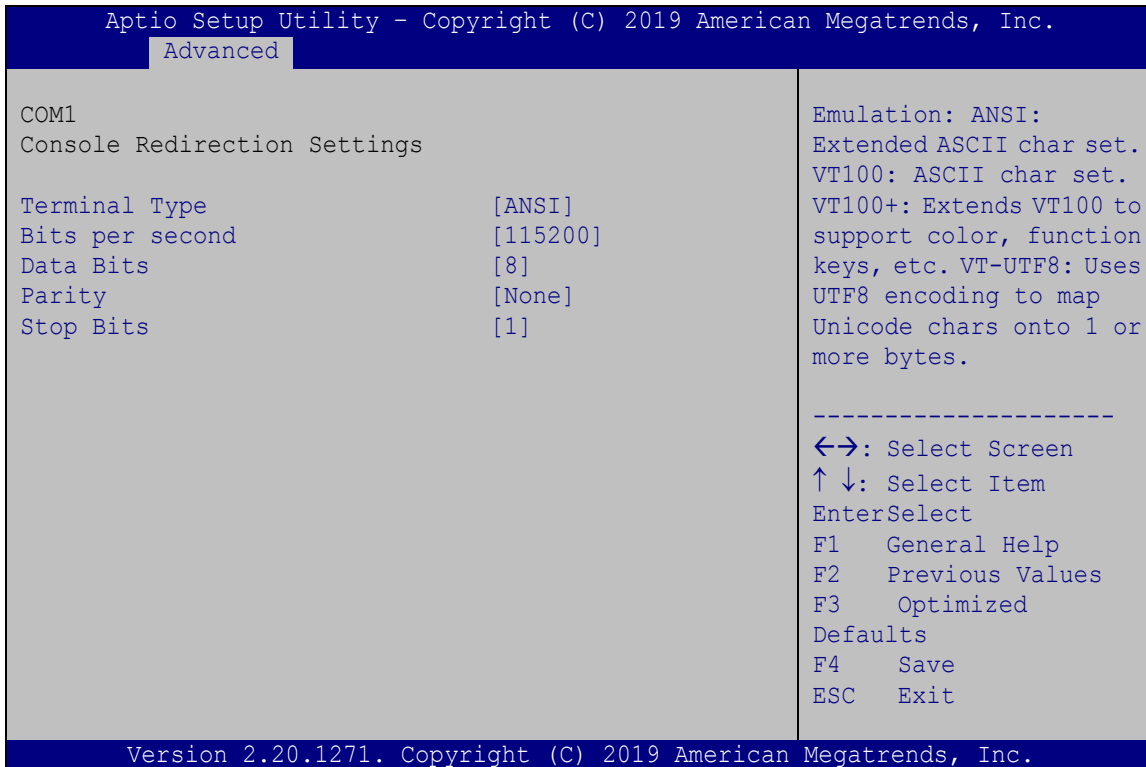

BIOS Menu 14: Console Redirection Settings

→ Terminal Type [ANSI]

Use the **Terminal Type** option to specify the remote terminal type.

- **VT100** The target terminal type is VT100
- **VT100+** The target terminal type is VT100+
- **VT-UTF8** The target terminal type is VT-UTF8
- **ANSI** **DEFAULT** The target terminal type is ANSI

→ Bits per second [115200]

Use the **Bits per second** option to specify the serial port transmission speed. The speed must match the other side. Long or noisy lines may require lower speeds.

- 9600** Sets the serial port transmission speed at 9600.
- 19200** Sets the serial port transmission speed at 19200.
- 57600** Sets the serial port transmission speed at 57600.
- 115200** **DEFAULT** Sets the serial port transmission speed at 115200.

→ Data Bits [8]

Use the **Data Bits** option to specify the number of data bits.

- 7** Sets the data bits at 7.
- 8** **DEFAULT** Sets the data bits at 8.

→ Parity [None]

Use the **Parity** option to specify the parity bit that can be sent with the data bits for detecting the transmission errors.

- None** **DEFAULT** No parity bit is sent with the data bits.
- Even** The parity bit is 0 if the number of ones in the data bits is even.
- Odd** The parity bit is 0 if the number of ones in the data bits is odd.
- Mark** The parity bit is always 1. This option does not provide error detection.
- Space** The parity bit is always 0. This option does not provide error detection.

NANO-ULT5 SBC

→ Stop Bits [1]

Use the **Stop Bits** option to specify the number of stop bits used to indicate the end of a serial data packet. Communication with slow devices may require more than 1 stop bit.

- 1 **DEFAULT** Sets the number of stop bits at 1.
- 2 Sets the number of stop bits at 2.

5.3.9 USB Configuration

Use the **USB Configuration** menu (**BIOS Menu 15**) to read USB configuration information and configure the USB settings.

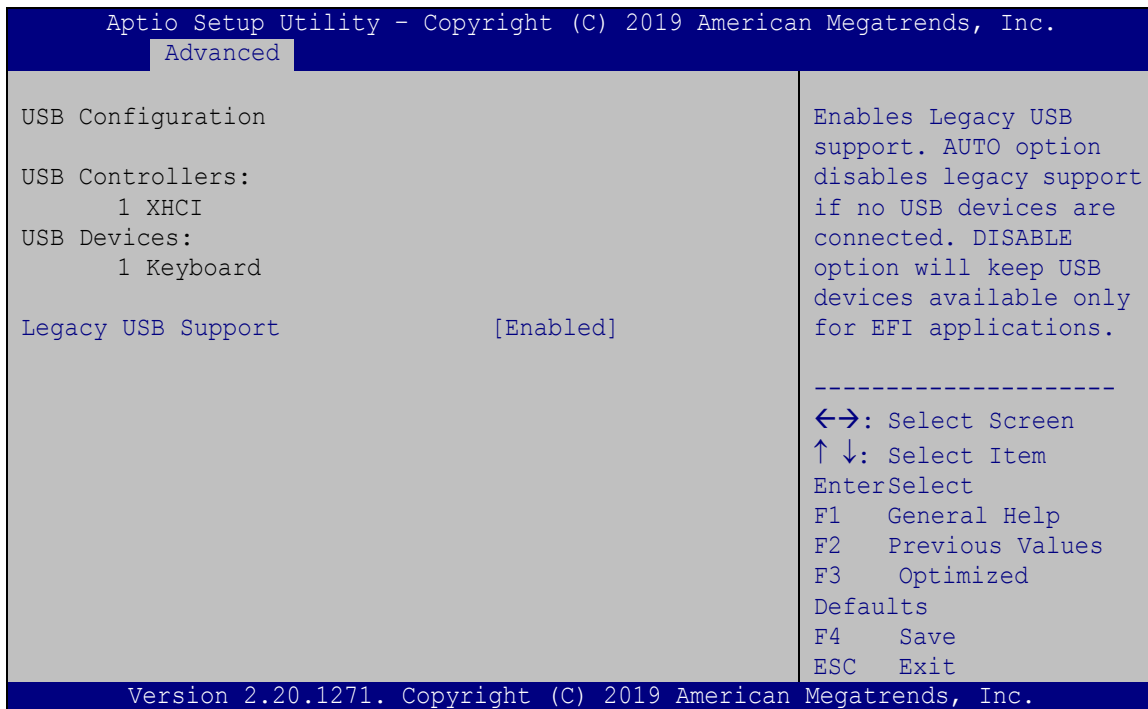

BIOS Menu 15: USB Configuration

→ USB Devices

The **USB Devices Enabled** field lists the USB devices that are enabled on the system

➔ **Legacy USB Support [Enabled]**

Use the **Legacy USB Support** BIOS option to enable USB mouse and USB keyboard support. Normally if this option is not enabled, any attached USB mouse or USB keyboard does not become available until a USB compatible operating system is fully booted with all USB drivers loaded. When this option is enabled, any attached USB mouse or USB keyboard can control the system even when there is no USB driver loaded onto the system.

- ➔ **Enabled** **DEFAULT** Legacy USB support enabled
- ➔ **Disabled** Legacy USB support disabled
- ➔ **Auto** Legacy USB support disabled if no USB devices are connected

5.3.10 CSM Configuration

Use the **CSM Configuration** menu (**BIOS Menu 16**) to configure Compatibility Support Module (CSM).

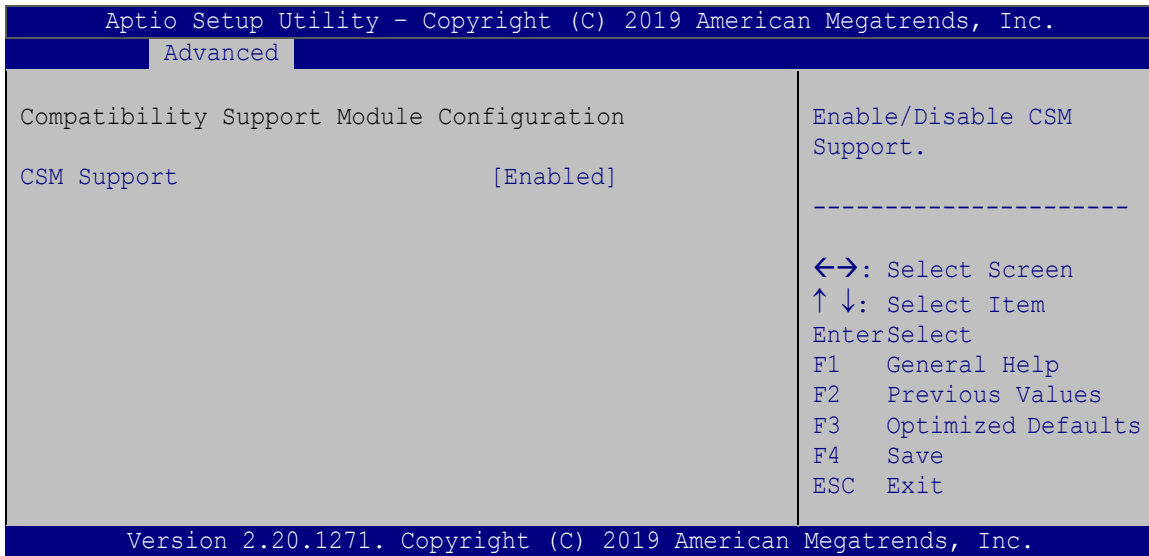

BIOS Menu 16: CSM Configuration

NANO-ULT5 SBC

→ CSM Support [Enabled]

Use the **CSM Support** BIOS option to enable or disable CSM support.

- **Disabled** CSM support disabled
- **Enabled** **DEFAULT** CSM support enabled

5.3.11 NVMe Configuration

Use the **NVMe Configuration (BIOS Menu 17)** menu to display the NVMe controller and device information.

```

Aptio Setup Utility - Copyright (C) 2018 American Megatrends, Inc.
  Advanced
-----
NVMe controller and Drive information
No NVMe Device Found

-----
→←: Select Screen
↑↓: Select Item
Enter: Select
+/-: Change Opt.
F1: General Help
F2: Previous Values
F3: Optimized Defaults
F4: Save & Exit
ESC: Exit

Version 2.20.1271. Copyright (C) 2018 American Megatrends, Inc.
  
```

BIOS Menu 17: NVMe Configuration

5.3.12 IEI Feature

Use the **IEI Feature** menu (**BIOS Menu 18**) to configure One Key Recovery function.

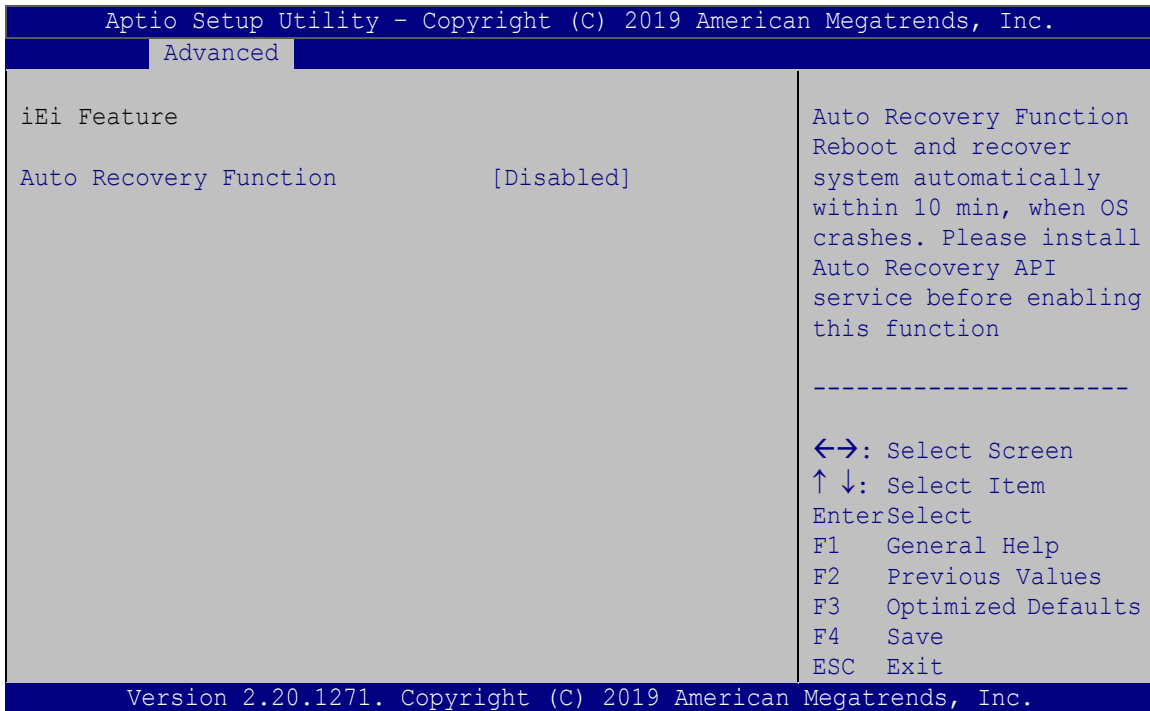

BIOS Menu 18: IEI Feature

→ Auto Recovery Function [Disabled]

Use the **Auto Recovery Function** BIOS option to enable or disable the auto recovery function of the IEI One Key Recovery.

- **Disabled** **DEFAULT** Auto recovery function disabled
- **Enabled** Auto recovery function enabled

NANO-ULT5 SBC

5.4 Chipset

Use the **Chipset** menu (**BIOS Menu 19**) to configure the system chipset.

```

Aptio Setup Utility - Copyright (C) 2019 American Megatrends, Inc.
Main    Advanced  Chipset    Boot    Security  Save & Exit  Server Mgmt

> System Agent (SA) Configuration
> PCH-IO Configuration

System Agent (SA)
Parameters

-----
<=>: Select Screen
↑↓: Select Item
Enter>Select
+ - Change Opt.
F1  General Help
F2  Previous Values
F3  Optimized Defaults
F4  Save & Exit
ESC Exit

Version 2.20.1271. Copyright (C) 2019 American Megatrends, Inc.
    
```

BIOS Menu 19: Chipset

5.4.1 System Agent (SA) Configuration

Use the **System Agent (SA) Configuration** menu (**BIOS Menu 20**) to configure the System Agent (SA) parameters.

```

Aptio Setup Utility - Copyright (C) 2019 American Megatrends, Inc.
Chipset

System Agent (SA) Configuration
VT-d                               Supported

> Memory Configuration
> Graphics Configuration

VT-d                               [Disabled]

Memory Configuration
Parameters

-----
<=>: Select Screen
↑↓: Select Item
Enter>Select
+ - Change Opt.
F1  General Help
F2  Previous Values
F3  Optimized Defaults
F4  Save & Exit
ESC Exit

Version 2.20.1271. Copyright (C) 2019 American Megatrends, Inc.
    
```

BIOS Menu 20: System Agent (SA) Configuration

➔ **VT-d [Disabled]**

Use the **VT-d** option to enable or disable VT-d support.

- ➔ **Disabled** **DEFAULT** Disable VT-d support.
- ➔ **Enabled** Enable VT-d support.

5.4.1.1 Memory Configuration

Use the **Memory Configuration** submenu (**BIOS Menu 21**) to display the memory information.

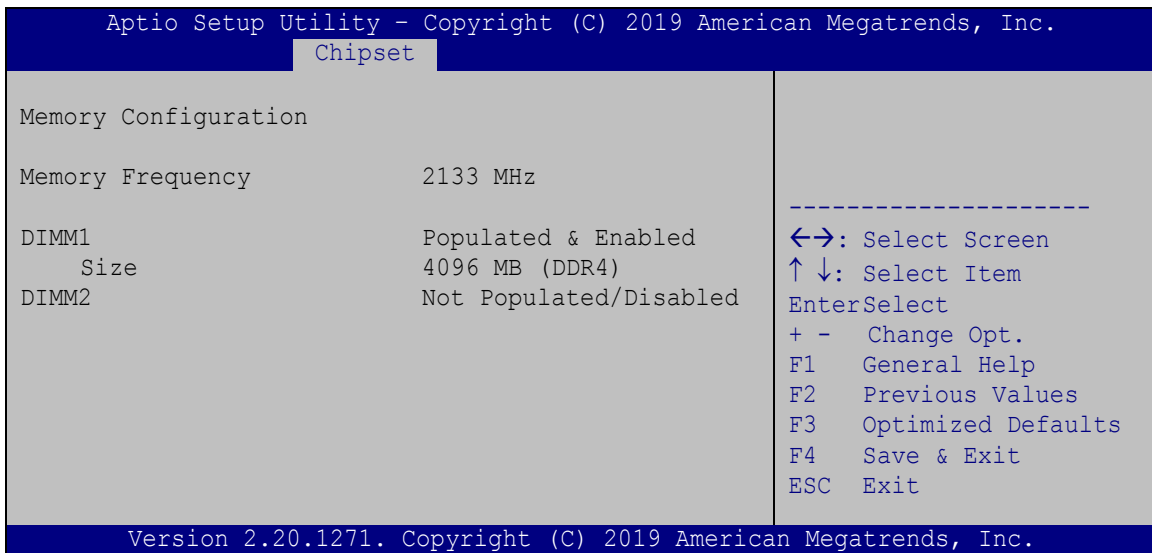

BIOS Menu 21: Memory Configuration

NANO-ULT5 SBC

5.4.1.2 Graphics Configuration

Use the **Graphics Configuration** menu (**BIOS Menu 22**) to configure the graphics settings.

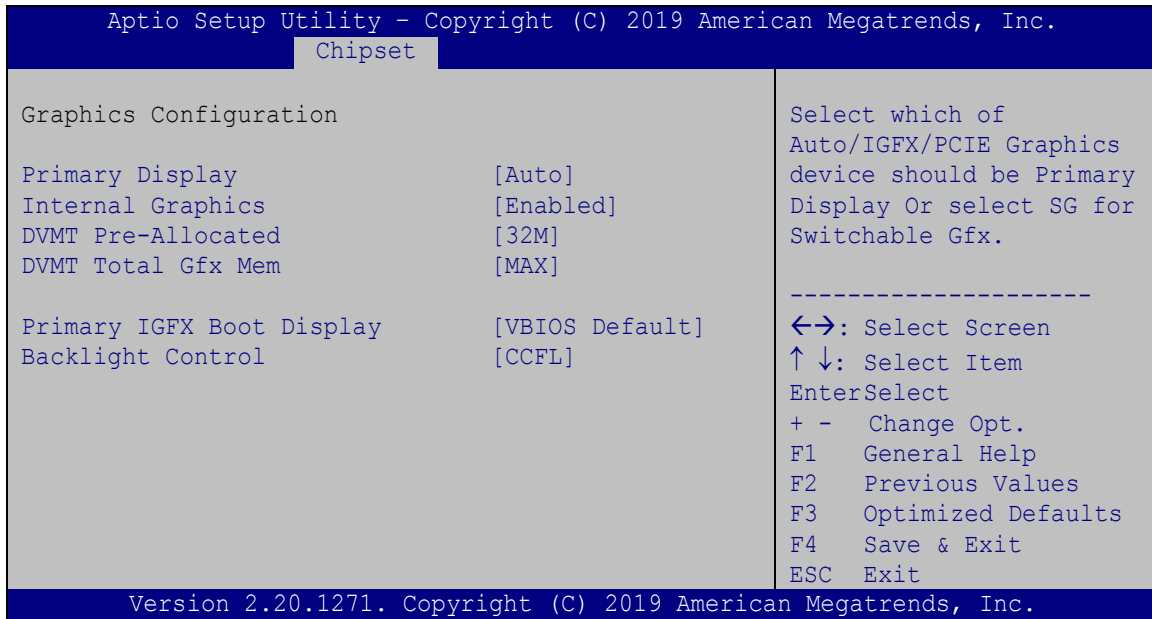

BIOS Menu 22: Graphics Configuration

→ Primary Display [Auto]

Use the **Primary Display** option to select the graphics controller used as the primary boot device. Configuration options are listed below:

- Auto **DEFAULT**
- IGFX
- PCI

→ Internal Graphics [Enabled]

Use the **Internal Graphics** option to enable or disable the internal graphics device.

- **Auto** The internal graphics device is automatically detected and enabled.
- **Disabled** Disable the internal graphics device.

- **Enabled** **DEFAULT** Enable the internal graphics device. The following options/submenu appear with values that can be selected:

DVMT Pre-Allocated

DVMT Total Gfx Mem

LCD Control

→ **DVMT Pre-Allocated [32M]**

Use the **DVMT Pre-Allocated** option to set the amount of system memory allocated to the integrated graphics processor when the system boots. The system memory allocated can then only be used as graphics memory, and is no longer available to applications or the operating system. Configuration options are listed below:

- 32M **DEFAULT**
- 64M

→ **DVMT Total Gfx Mem [MAX]**

Use the **DVMT Total Gfx Mem** option to select DVMT 5.0 total graphic memory size used by the internal graphics device. The following options are available:

- 128M
- 256M
- MAX **DEFAULT**

→ **Primary IGFX Boot Display [VBIOS Default]**

Use the **Primary IGFX Boot Display** option to select the display device used by the system when it boots.

- VBIOS Default **DEFAULT**
- HDMI1
- DP1
- LVDS1

NANO-ULT5 SBC

→ Backlight Control Mode [CCFL]

Use the **Backlight Control Mode** option to specify the backlight control mode. Configuration options are listed below.

- LED
- CCFL **DEFAULT**

5.4.2 PCH-IO Configuration

Use the **PCH-IO Configuration** menu (**BIOS Menu 23**) to configure the PCH-IO chipset.

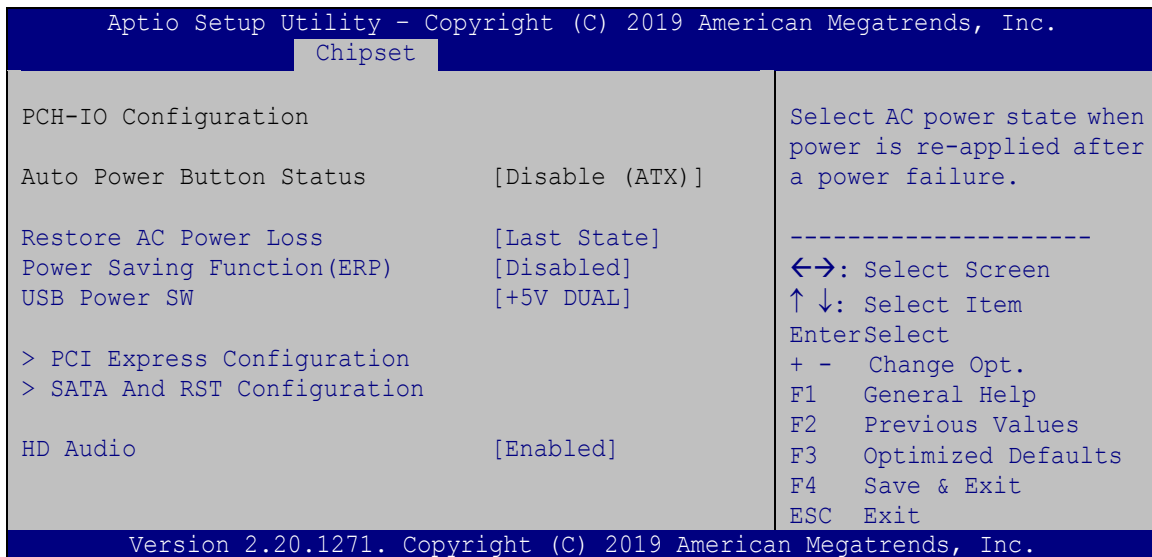

BIOS Menu 23: PCH-IO Configuration

→ Restore AC Power Loss [Last State]

Use the **Restore AC Power** BIOS option to specify what state the system returns to if there is a sudden loss of power to the system.

- **Power Off** The system remains turned off
- **Power On** The system turns on
- **Last State** **DEFAULT** The system returns to its previous state. If it was on, it turns itself on. If it was off, it remains off.

→ Power Saving Function(ERP) [Disabled]

Use the **Power Saving Function(ERP)** BIOS option to enable or disable the power saving function.

- Disabled DEFAULT** Power saving function is disabled.
- Enabled** Power saving function is enabled. It will reduce power consumption when the system is off.

→ USB Power SW [+5V DUAL]

Use the **USB Power SW** BIOS option to configure whether to provide power to the USB connectors when the system is in S3/S4 sleep state. This option is valid only when the above **Power Saving Function (ERP)** BIOS option is disabled.

- +5V DEFAULT** Power is provided to the USB connectors when the system is in S3/S4 sleep state
DUAL
- +5V** Power is not provided to the USB connectors when the system is in S3/S4 sleep state

→ HD Audio [Enabled]

Use the **HD Audio** BIOS option to enable or disable the High Definition Audio controller.

- Disabled** The High Definition Audio controller is disabled.
- Enabled DEFAULT** The High Definition Audio controller is enabled.

NANO-ULT5 SBC

5.4.2.1 PCI Express Configuration

Use the **PCI Express Configuration** submenu (**BIOS Menu 24**) to configure the PCI Express slots.

```

Aptio Setup Utility - Copyright (C) 2019 American Megatrends, Inc.
  Chipset
-----
PCI Express Configuration
> M2_A1
> MINI_PCIE1
> M2_M2

PCI Express Root Port Settings.

-----
<=>: Select Screen
↑ ↓: Select Item
Enter: Select
+ - Change Opt.
F1  General Help
F2  Previous Values
F3  Optimized Defaults
F4  Save & Exit
ESC Exit

Version 2.20.1271. Copyright (C) 2019 American Megatrends, Inc.
  
```

BIOS Menu 24: PCI Express Configuration

5.4.2.1.1 M2_A1 / MINI_PCIE1 / M2_M2 Configuration

```

Aptio Setup Utility - Copyright (C) 2019 American Megatrends, Inc.
  Advanced
-----
M.2_A1 [Enabled]
PCIe Speed [Auto]
Detect Non-Compliance Device [Disabled]

Select PCI Express port speed.

-----
-><: Select Screen
↑ ↓: Select Item
Enter: Select
+/-: Change Opt.
F1: General Help
F2: Previous Values
F3: Optimized Defaults
F4: Save & Exit
ESC: Exit

Version 2.20.1271. Copyright (C) 2019 American Megatrends, Inc.
  
```

BIOS Menu 25: M2_A1 / MINI_PCIE1 / M2_M2 Configuration

→ M2_A1 / MINI_PCIE1 / M2_M2 [Enabled]

Use the **M2_A1 / MINI_PCIE1 / M2_M2** option to enable or disable the M.2 or PCIe Mini expansion slots.

→ Disabled Disables the expansion slot.

→ Enabled **DEFAULT** Enables the expansion slot.

→ PCIe Speed [Auto]

Use this option to select the support type of the PCI Express slots. The following options are available:

- Auto **Default**
- Gen1
- Gen2
- Gen3

→ Detect Non-Compliance Device [Disabled]

Use the **Detect Non-Compliance Device** option to enable or disable detecting if a non-compliance PCI Express device is connected to the PCI Express slot.

→ Disabled **DEFAULT** Disables to detect if a non-compliance PCI Express device is connected to the PCI Express slot.

→ Enabled Enables to detect if a non-compliance PCI Express device is connected to the PCI Express slot.

NANO-ULT5 SBC

5.4.2.2 SATA And RST Configuration

Use the **SATA And RST Configuration** menu (**BIOS Menu 26**) to change and/or set the configuration of the SATA devices installed in the system.

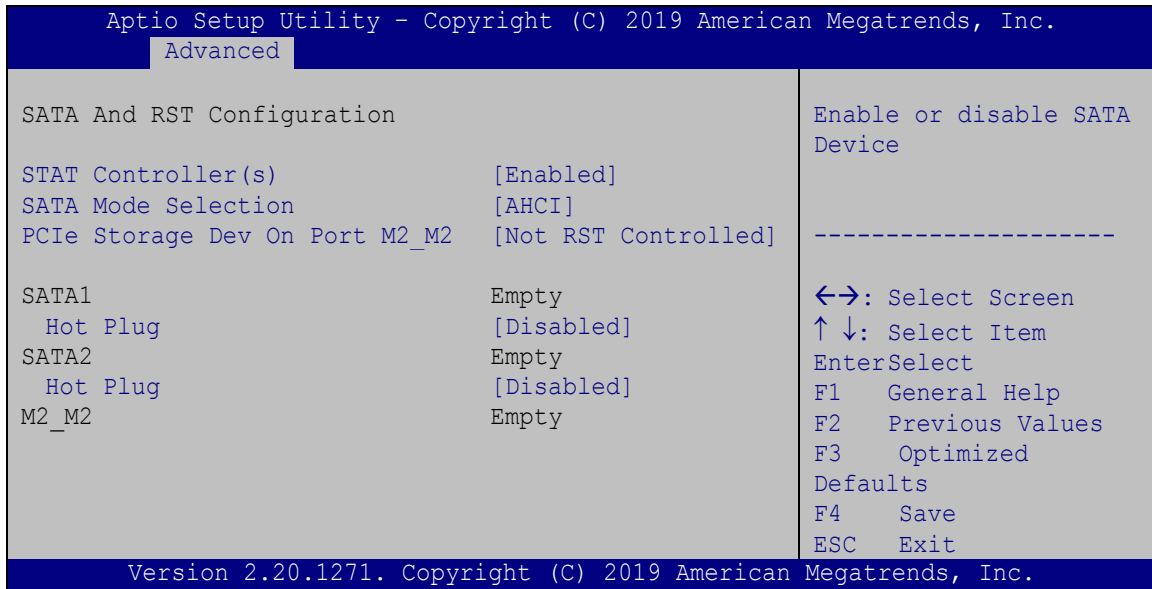

BIOS Menu 26: SATA and RST Configuration

→ STAT Controller(s) [Enabled]

Use the **STAT Controller(s)** option to enable or disable the SATA device.

- **Enabled** **DEFAULT** Enables the SATA device.
- **Disabled** Disables the SATA device.

→ SATA Mode Selection [AHCI]

Use the **SATA Mode Selection** option to configure how the SATA controller(s) operate.

- AHCI** **DEFAULT** Configures SATA devices as AHCI device.
- Intel RST
Premium
with Intel
Optane
System
Acceleration** Configures SATA devices as RAID device.

→ Hot Plug [Disabled]

Use the **Hot Plug** option to enable or disable the SATA device hot plug.

- Disabled** **DEFAULT** Disables the SATA device hot plug.
- Enabled** Enables the SATA device hot plug

→ PCIe Storage Dev On Port M2_M2 [Not RST Controlled]

Use the **PCIe Storage Dev On Port M2_M2** option to enable or disable RST PCIe storage remapping.

- RST
Controlled** Enables RST PCIe storage remapping. It is only supported by UEFI, so the **CSM Support** option must be disabled.
- Not RST
Controlled** **DEFAULT** Disables RST PCIe storage remapping.

NANO-ULT5 SBC

5.5 Security

Use the **Security** menu (**BIOS Menu 27**) to set system and user passwords.

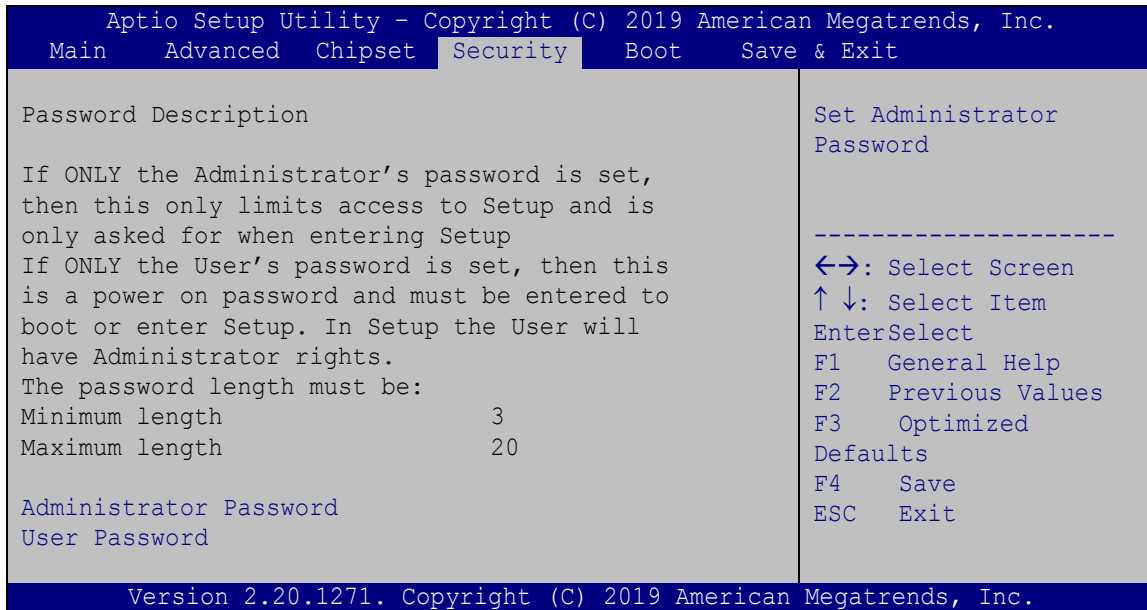

BIOS Menu 27: Security

→ Administrator Password

Use the **Administrator Password** to set or change a administrator password.

→ User Password

Use the **User Password** to set or change a user password.

5.6 Boot

Use the **Boot** menu (**BIOS Menu 28**) to configure system boot options.

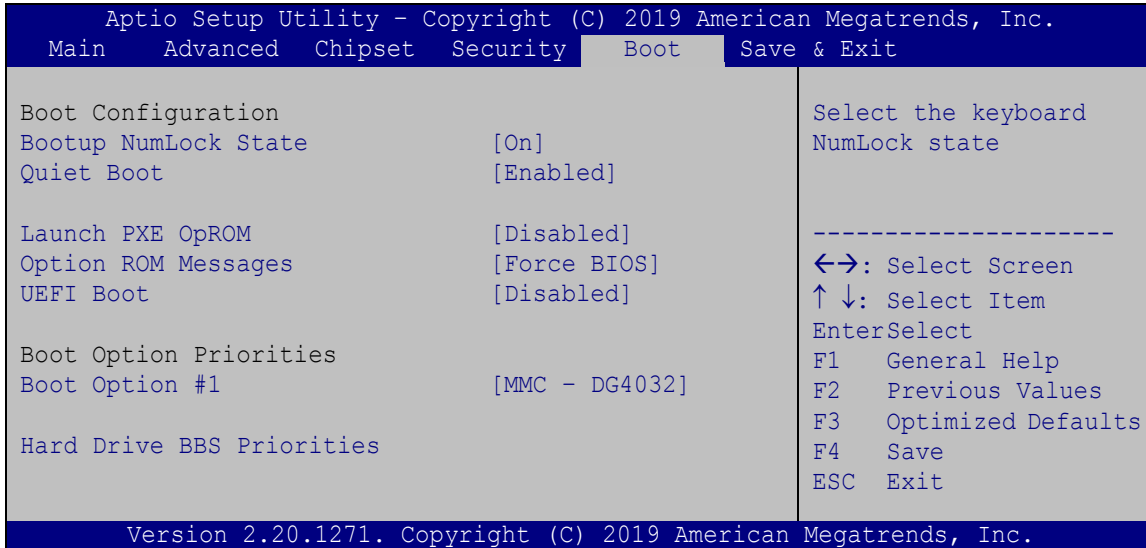

BIOS Menu 28: Boot

→ Bootup NumLock State [On]

Use the **Bootup NumLock State** BIOS option to specify if the number lock setting must be modified during boot up.

- **On** **DEFAULT** Allows the Number Lock on the keyboard to be enabled automatically when the computer system boots up. This allows the immediate use of the 10-key numeric keypad located on the right side of the keyboard. To confirm this, the Number Lock LED light on the keyboard is lit.

- **Off** Does not enable the keyboard Number Lock automatically. To use the 10-keys on the keyboard, press the Number Lock key located on the upper left-hand corner of the 10-key pad. The Number Lock LED on the keyboard lights up when the Number Lock is engaged.

NANO-ULT5 SBC

→ Quiet Boot [Enabled]

Use the **Quiet Boot** BIOS option to select the screen display when the system boots.

- **Disabled** Normal POST messages displayed
- **Enabled** **DEFAULT** OEM Logo displayed instead of POST messages

→ Launch PXE OpROM [Disabled]

Use the **Launch PXE OpROM** option to enable or disable boot option for legacy network devices.

- **Disabled** **DEFAULT** Ignore all PXE Option ROMs
- **Enabled** Load PXE Option ROMs.

→ Option ROM Messages [Force BIOS]

Use the **Option ROM Messages** option to set the Option ROM display mode.

- **Force BIOS** **DEFAULT** Sets display mode to force BIOS.
- **Keep Current** Sets display mode to current.

→ UEFI Boot [Disabled]

Use the **UEFI Boot** option to enable or disable to boot from the UEFI devices.

- **Disabled** **DEFAULT** Boot from UEFI devices is disabled.
- **Enabled** Boot from UEFI devices is enabled.

→ Boot Option Priority

Use the **Boot Option Priority** function to set the system boot sequence from the available devices. The drive sequence also depends on the boot sequence in the individual device section.

5.7 Exit

Use the **Exit** menu (**BIOS Menu 29**) to load default BIOS values, optimal failsafe values and to save configuration changes.

```
Aptio Setup Utility - Copyright (C) 2019 American Megatrends, Inc.
Main  Advanced  Chipset  Security  Boot  Save & Exit
-----
Save Changes and Reset
Discard Changes and Reset

Restore Defaults
Save as User Defaults
Restore User Defaults

Reset the system after
saving the changes.

-----
<=>: Select Screen
↑ ↓: Select Item
Enter>Select
F1  General Help
F2  Previous Values
F3  Optimized
Defaults
F4  Save
ESC Exit

Version 2.20.1271. Copyright (C) 2019 American Megatrends, Inc.
```

BIOS Menu 29: Exit

→ Save Changes and Reset

Use the **Save Changes and Reset** option to save the changes made to the BIOS options and to exit the BIOS configuration setup program.

→ Discard Changes and Reset

Use the **Discard Changes and Reset** option to exit the system without saving the changes made to the BIOS configuration setup program.

→ Restore Defaults

Use the **Restore Defaults** option to load the optimal default values for each of the parameters on the Setup menus. **F3 key can be used for this operation.**

NANO-ULT5 SBC

→ Save as User Defaults

Use the **Save as User Defaults** option to save the changes done so far as user defaults.

→ Restore User Defaults

Use the **Restore User Defaults** option to restore the user defaults to all the setup options.

Chapter

6

Software Drivers

NANO-ULT5 SBC

6.1 Available Drivers

All the drivers for the NANO-ULT5 are available on IEI Resource Download Center (<https://download.ieiworld.com>). Type NANO-ULT5 and press Enter to find all the relevant software, utilities, and documentation.

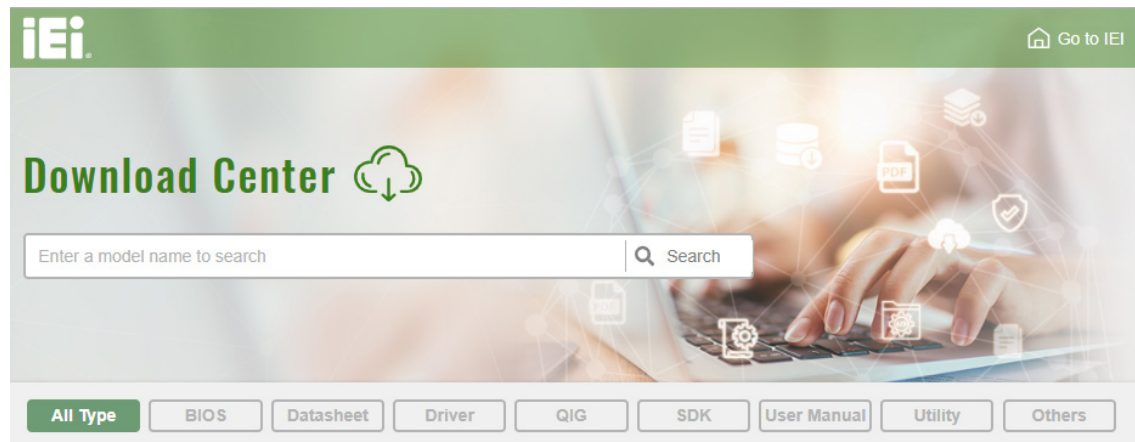
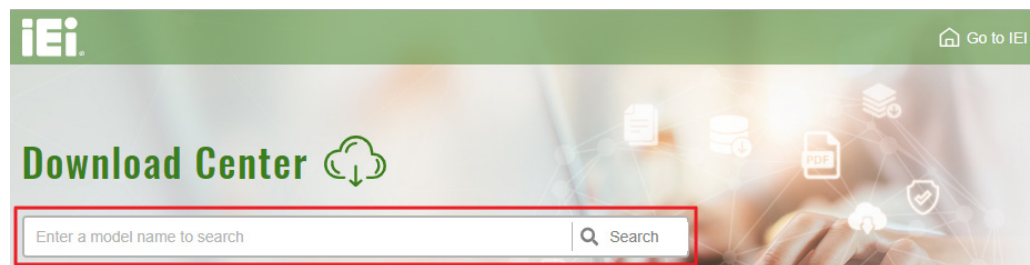

Figure 6-1: IEI Resource Download Center

6.2 Driver Download

To download drivers from IEI Resource Download Center, follow the steps below.

Step 1: Go to <https://download.ieiworld.com>. Type NANO-ULT5 and press Enter.



Step 2: All product-related software, utilities, and documentation will be listed. You can choose **Driver** to filter the result.

[All Type](#)
[BIOS](#)
[Datasheet](#)
[Driver](#)
[QIG](#)
[SDK](#)
[User Manual](#)
[Utility](#)
[Others](#)

WAFER-BT-i1 [Product Info](#)

[Embedded Computer](#)
[Single Board Computer](#)
[Embedded Board](#)

3.5" SBC with Intel® 22nm Atom™/Celeron® on-board SoC

Driver

File Name	Published	Version	File Checksum
7B000-001033-RS V2.3.iso (2.23 GB)	2017/10/03	2.30	3B2DB1F792779A93A8F50DDBC3943E30

Step 3: Click the driver file name on the page and you will be prompted with the following window. You can download the entire ISO file (❶), or click the small arrow to find an individual driver and click the file name to download (❷).

7B000-001168-RS_V1.4.iso

❶ [Click here to download entire ISO file. \(2.99 GB\)](#)

* Download individual file *

- Docs
 - 1.Chipset
 - ❷ 10.1.1.12.zip (2.7 MB)
 - 2.VGA
 - 3.Audio
 - 4.Lan
 - 5.USB 3.0
 - 6.Serial IO
 - 7.TXE
 - 8.Manual



NOTE:

To install software from the downloaded ISO image file in Windows 8, 8.1 or 10, double-click the ISO file to mount it as a virtual drive to view its content. On Windows 7 system, an additional tool (such as Virtual CD-ROM Control Panel from Microsoft) is needed to mount the file.

NANO-ULT5 SBC



NOTE:

The Intel TXE requires that Microsoft's "Kernel-Mode Driver Framework (KMDf) version 1.11 update for Windows 7" must be installed first on Windows 7 OS. If the KMDf is not installed, either error 37 or error 28 may appear on the Intel TXE device in Device Manager.

Please find the KMDf version 1.11 update for Windows 7 in the TXE driver folder in the driver CD or click the following link to download it.

<http://www.microsoft.com/en-us/download/details.aspx?id=38423>

Appendix

A

Regulatory Compliance

DECLARATION OF CONFORMITY



This equipment has been tested and found to comply with specifications for CE marking. If the user modifies and/or installs other devices in the equipment, the CE conformity declaration may no longer apply.

FCC WARNING



This equipment complies with Part 15 of the FCC Rules. Operation is subject to the following two conditions:

- This device may not cause harmful interference, and
- This device must accept any interference received, including interference that may cause undesired operation.

This equipment has been tested and found to comply with the limits for a Class A digital device, pursuant to part 15 of the FCC Rules. These limits are designed to provide reasonable protection against harmful interference when the equipment is operated in a commercial environment. This equipment generates, uses, and can radiate radio frequency energy and, if not installed and used in accordance with the instruction manual, may cause harmful interference to radio communications. Operation of this equipment in a residential area is likely to cause harmful interference in which case the user will be required to correct the interference at his own expense.

Appendix

B

Product Disposal

NANO-ULT5 SBC



CAUTION:

Risk of explosion if battery is replaced by an incorrect type. Only certified engineers should replace the on-board battery.

Dispose of used batteries according to instructions and local regulations.

- Outside the European Union–If you wish to dispose of used electrical and electronic products outside the European Union, please contact your local authority so as to comply with the correct disposal method.
- Within the European Union–The device that produces less waste and is easier to recycle is classified as electronic device in terms of the European Directive 2012/19/EU (WEEE), and must not be disposed of as domestic garbage.

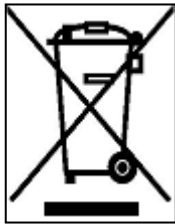

EU-wide legislation, as implemented in each Member State, requires that waste electrical and electronic products carrying the mark (left) must be disposed of separately from normal household waste. This includes monitors and electrical accessories, such as signal cables or power cords. When you need to dispose of your device, please follow the guidance of your local authority, or ask the shop where you purchased the product. The mark on electrical and electronic products only applies to the current European Union Member States.

Please follow the national guidelines for electrical and electronic product disposal.

Appendix

C

BIOS Menu Options

NANO-ULT5 SBC

<input type="checkbox"/>	System Date [xx/xx/xx]	79
<input type="checkbox"/>	System Time [xx:xx:xx]	79
<input type="checkbox"/>	Intel® (VMX) Virtualization Technology [Disabled]	80
<input type="checkbox"/>	Active Processor Cores [All]	80
<input type="checkbox"/>	Hyper-threading [Enabled].....	81
<input type="checkbox"/>	Intel® SpeedStep™ [Enabled]	81
<input type="checkbox"/>	C State [Disabled]	81
<input type="checkbox"/>	Unconfigure ME [Disabled]	82
<input type="checkbox"/>	Security Device Support [Disable]	83
<input type="checkbox"/>	ACPI Sleep State [S3 (Suspend to RAM)].....	84
<input type="checkbox"/>	Wake system with Fixed Time [Disabled].....	85
<input type="checkbox"/>	PC Health Status	86
<input type="checkbox"/>	CPU_FAN1 Smart Fan Control [Auto Mode]	87
<input type="checkbox"/>	Auto mode fan start temperature [40].....	88
<input type="checkbox"/>	Auto mode fan off temperature [30].....	88
<input type="checkbox"/>	Auto mode fan start PWM [30].....	88
<input type="checkbox"/>	Auto mode fan slope PWM [2]	89
<input type="checkbox"/>	Serial Port [Enabled].....	90
<input type="checkbox"/>	Console Redirection [Disabled]	91
<input type="checkbox"/>	Legacy Serial Redirection Port [COM1].....	92
<input type="checkbox"/>	Terminal Type [ANSI].....	93
<input type="checkbox"/>	Bits per second [115200].....	94
<input type="checkbox"/>	Data Bits [8]	94
<input type="checkbox"/>	Parity [None].....	94
<input type="checkbox"/>	Stop Bits [1].....	95
<input type="checkbox"/>	USB Devices	95
<input type="checkbox"/>	Legacy USB Support [Enabled].....	96
<input type="checkbox"/>	CSM Support [Enabled].....	97
<input type="checkbox"/>	Auto Recovery Function [Disabled].....	98
<input type="checkbox"/>	VT-d [Disabled].....	100
<input type="checkbox"/>	Primary Display [Auto]	101
<input type="checkbox"/>	Internal Graphics [Enabled].....	101
<input type="checkbox"/>	DVMT Pre-Allocated [32M]	102
<input type="checkbox"/>	DVMT Total Gfx Mem [MAX].....	102
<input type="checkbox"/>	Primary IGFX Boot Display [VBIOS Default]	102

<input type="checkbox"/>	Backlight Control Mode [CCFL].....	103
<input type="checkbox"/>	Restore AC Power Loss [Last State]	103
<input type="checkbox"/>	Power Saving Function(ERP) [Disabled].....	104
<input type="checkbox"/>	USB Power SW [+5V DUAL].....	104
<input type="checkbox"/>	HD Audio [Enabled]	104
<input type="checkbox"/>	M2_A1 / MINI_PCIE1 / M2_M2 [Enabled].....	106
<input type="checkbox"/>	PCIe Speed [Auto].....	106
<input type="checkbox"/>	Detect Non-Compliance Device [Disabled]	106
<input type="checkbox"/>	STAT Controller(s) [Enabled].....	107
<input type="checkbox"/>	SATA Mode Selection [AHCI].....	108
<input type="checkbox"/>	Hot Plug [Disabled]	108
<input type="checkbox"/>	PCIe Storage Dev On Port M2_M2 [Not RST Controlled].....	108
<input type="checkbox"/>	Administrator Password	109
<input type="checkbox"/>	User Password	109
<input type="checkbox"/>	Bootup NumLock State [On].....	110
<input type="checkbox"/>	Quiet Boot [Enabled]	111
<input type="checkbox"/>	Launch PXE OpROM [Disabled]	111
<input type="checkbox"/>	Option ROM Messages [Force BIOS].....	111
<input type="checkbox"/>	UEFI Boot [Disabled]	111
<input type="checkbox"/>	Boot Option Priority.....	111
<input type="checkbox"/>	Save Changes and Reset	112
<input type="checkbox"/>	Discard Changes and Reset	112
<input type="checkbox"/>	Restore Defaults	112
<input type="checkbox"/>	Save as User Defaults	113
<input type="checkbox"/>	Restore User Defaults	113

Appendix

D

Digital I/O Interface

The DIO connector on the NANO-ULT5 is interfaced to GPIO ports on the Super I/O chipset. The DIO has both 8-bit digital inputs and 8-bit digital outputs. The digital inputs and digital outputs are generally control signals that control the on/off circuit of external devices or TTL devices. Data can be read or written to the selected address to enable the DIO functions.



NOTE:

For further information, please refer to the datasheet for the Super I/O chipset.

The BIOS interrupt call **INT 15H** controls the digital I/O.

INT 15H:

AH – 6FH	
<u>Sub-function:</u>	
AL – 8	:Set the digital port as INPUT
AL	:Digital I/O input value

Assembly Language Sample 1

```
MOV    AX, 6F08H    ;setting the digital port as input
INT    15H          ;
```

AL low byte = value

NANO-ULT5 SBC

AH – 6FH	
<u>Sub-function:</u>	
AL – 9	:Set the digital port as OUTPUT
BL	:Digital I/O output value

Assembly Language Sample 2

```
MOV    AX, 6F09H      ;setting the digital port as output  
MOV    BL, 09H        ;digital value is 09H  
INT    15H           ;
```

Digital Output is 1001b

Appendix

E

Watchdog Timer



NOTE:

The following discussion applies to DOS. Contact IEI support or visit the IEI website for drivers for other operating systems.

The Watchdog Timer is a hardware-based timer that attempts to restart the system when it stops working. The system may stop working because of external EMI or software bugs. The Watchdog Timer ensures that standalone systems like ATMs will automatically attempt to restart in the case of system problems.

A BIOS function call (INT 15H) is used to control the Watchdog Timer.

INT 15H:

AH – 6FH Sub-function:	
AL – 2:	Sets the Watchdog Timer's period.
BL:	Time-out value (Its unit-second is dependent on the item "Watchdog Timer unit select" in CMOS setup).

Table E-1: AH-6FH Sub-function

Call sub-function 2 to set the time-out period of Watchdog Timer first. If the time-out value is not zero, the Watchdog Timer starts counting down. When the timer value reaches zero, the system resets. To ensure that this reset condition does not occur, calling sub-function 2 must periodically refresh the Watchdog Timer. However, the watchdog timer is disabled if the time-out value is set to zero.

A tolerance of at least 10% must be maintained to avoid unknown routines within the operating system (DOS), such as disk I/O that can be very time-consuming.

**NOTE:**

The Watchdog Timer is activated through software. The software application that activates the Watchdog Timer must also deactivate it when closed. If the Watchdog Timer is not deactivated, the system will automatically restart after the Timer has finished its countdown.

EXAMPLE PROGRAM:

```
; INITIAL TIMER PERIOD COUNTER
```

```
;
```

```
W_LOOP:
```

```
;
```

```
    MOV     AX, 6F02H      ;setting the time-out value  
    MOV     BL, 30        ;time-out value is 48 seconds  
    INT     15H
```

```
;
```

```
; ADD THE APPLICATION PROGRAM HERE
```

```
;
```

```
    CMP     EXIT_AP, 1    ;is the application over?  
    JNE     W_LOOP       ;No, restart the application
```

```
    MOV     AX, 6F02H    ;disable Watchdog Timer  
    MOV     BL, 0       ;  
    INT     15H
```

```
;
```

```
; EXIT ;
```

Appendix

F

Error Beep Code

F.1 PEI Beep Codes

Number of Beeps	Description
1	Memory not Installed
1	Memory was installed twice (InstallPeiMemory routine in PEI Core called twice)
2	Recovery started
3	DXE IPL was not found
3	DXE Core Firmware Volume was not found
4	Recovery failed
4	S3 Resume failed
7	Reset PPI is not available

F.2 DXE Beep Codes

Number of Beeps	Description
1	Invalid password
4	Some of the Architectural Protocols are not available
5	No Console Output Devices are found
5	No Console Input Devices are found
6	Flash update is failed
7	Reset protocol is not available
8	Platform PCI resource requirements cannot be met



NOTE:

If you have any question, please contact IEI for further assistance.

Appendix

G

Hazardous Materials Disclosure

G.1 RoHS II Directive (2015/863/EU)

The details provided in this appendix are to ensure that the product is compliant with the RoHS II Directive (2015/863/EU). The table below acknowledges the presences of small quantities of certain substances in the product, and is applicable to RoHS II Directive (2015/863/EU).

Please refer to the following table.

Part Name	Toxic or Hazardous Substances and Elements									
	Lead (Pb)	Mercury (Hg)	Cadmium (Cd)	Hexavalent Chromium (CR(VI))	Polybrominated Biphenyls (PBB)	Polybrominated Diphenyl Ethers (PBDE)	Bis(2-ethylhexyl) phthalate (DEHP)	Butyl benzyl phthalate (BBP)	Dibutyl phthalate (DBP)	Diisobutyl phthalate (DIBP)
Housing	O	O	O	O	O	O	O	O	O	O
Printed Circuit Board	O	O	O	O	O	O	O	O	O	O
Metal Fasteners	O	O	O	O	O	O	O	O	O	O
Cable Assembly	O	O	O	O	O	O	O	O	O	O
Fan Assembly	O	O	O	O	O	O	O	O	O	O
Power Supply Assemblies	O	O	O	O	O	O	O	O	O	O
Battery	O	O	O	O	O	O	O	O	O	O
<p>O: This toxic or hazardous substance is contained in all of the homogeneous materials for the part is below the limit requirement in Directive (EU) 2015/863.</p> <p>X: This toxic or hazardous substance is contained in at least one of the homogeneous materials for this part is above the limit requirement in Directive (EU) 2015/863.</p>										

NANO-ULT5 SBC

G.2 China RoHS

此附件旨在确保本产品符合中国 RoHS 标准。以下表格标示此产品中某有毒物质的含量符合中国 RoHS 标准规定的限量要求。

本产品上会附有“环境友好使用期限”的标签，此期限是估算这些物质“不会有泄漏或突变”的年限。本产品可能包含有较短的环境友好使用期限的可替换元件，像是电池或灯管，这些元件将会单独标示出来。

部件名称	有毒有害物质或元素					
	铅 (Pb)	汞 (Hg)	镉 (Cd)	六价铬 (CR(VI))	多溴联苯 (PBB)	多溴二苯醚 (PBDE)
壳体	○	○	○	○	○	○
印刷电路板	○	○	○	○	○	○
金属螺帽	○	○	○	○	○	○
电缆组装	○	○	○	○	○	○
风扇组装	○	○	○	○	○	○
电力供应组装	○	○	○	○	○	○
电池	○	○	○	○	○	○

○: 表示该有毒有害物质在该部件所有物质材料中的含量均在 SJ/T11364-2014 與 GB/T26572-2011 标准规定的限量要求以下。

X: 表示该有毒有害物质至少在该部件的某一均质材料中的含量超出 SJ/T11364-2014 與 GB/T26572-2011 标准规定的限量要求。